

HSME[®]











Valves & Fittings









DIN 2353 Tube Fittings

DIN 2353 & ISO 8434-1



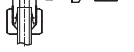

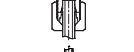

- Metric Tube OD: 4 mm - 42 mm OD
- Fitting Materials: Stainless Steel, Steel, and Brass
- Non Return and Ball Valves

Quality System Certificate  ISO 9001	HSE Management Certificates  ISO 14001 OHSAS18001	Nuclear Quality System Certificates 	PED97/23/EC 	Type Approval Certificates      	www.hsmecorp.com HSME[®] since 1976 Registered Trade Mark
---	---	--	--	--	--

Tube to Tube		Page	EO	EMB	VOLZ	VOSS	WALPRO
	EU Straight Union	10	G	E	G-V	111... 112...	P-GV
	EBU Bulkhead Union	10	SV	K	GS-V	137	P-GSV
	EBUW Weld Bulkhead Union	11	ESV	N	ES-V	141...	P-ESV
	EUR Reducing Union	12	GR	ER	GR-V		P-GV
	EL Union Elbow	13	W	F	W-V	119... 120...	P-WV
	EBL Bulkhead Union Elbow	14	WSV	L	WS-V	138...	P-WSV
	ET Union Tee	14	T	G	T-V	133... 134...	P-TV
	ETR Reducing Tee	15	TR	GR			P-TV
	EX Union Cross	16	K	H	K-V	135... 136...	P-KV

Tube to Male Thread

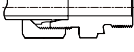
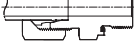
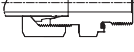
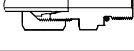

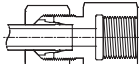
	ELM-R/MK Male Elbow (BSPT /Metric Tapered)	17	WE-R -M	B-R -M	WE-V..R ..M	115...116... 113...114...	P-WEV..RK ..MK
	EMC-N Male Connector (NPT Tapered)	18	GE-NPT	A/NPT	GE-V..NPT	105...106	P-GEV..NPT
	EMC-R Male Connector (BSPT Tapered)	19,20	GE-R	A-R	GV-V..R	110...	P-GEV..R
	EMC-GB Male Connector (BSPP Parallel)	19,20	GE-R	AP-R	GE-V..RK	103...104...	P-GEV..RK
	EMC-MK Male Connector (Metric Tapered)	21	GE-M	A-M	GE-V..M	109...	P-GEV..M
	EMC-MB Male Connector (Metric Parallel)	21	GE-M	A-M	GE-V..M	109...	P-GEV..M
	EMC-GE Male Connector (BSPP Parallel) with ED-Ring	22	GE-R-ED	A-RWD	GE-V..RWD	184...	P-GEV..R-WD
	EMC-ME Male Connector (Metric Parallel) with ED-Ring	23	GE-M-ED	A-MWD	GE-V.. MWD	184...	P-GEV..M-WD
	EMC-UF/MF Male Connector (Unified /Metric Parallel) with O-Ring	24	GE-UNF/UN GEO	A/UNF/UN A/O		182...	P-GEV..U P-GEV..M-FO,F

Tube to Female Port	Page	EO	EMB	VOLZ	VOSS	WALPRO
 EFC-G/M Female Connector (BSPP / Metric Parallel)	25	GAI-R -M	AL-R -M	GAIV..R ..M	144... 134...	P-GAV..R ..M

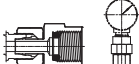
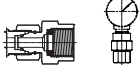
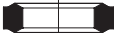

Gauge Female Connector

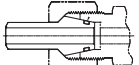
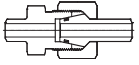

 EFC-GG Female Connector (BSPP Parallel)	26	MAV	O	MA-V ...R	142...	V-MAV..R
 EGA-GG Standpipe Female Connector (BSPP Parallel)	26			MAEV ...R		P-EMAS...R-SV
 EGE-GG Swivel Female Connector (BSPP Parallel)	27	MAVE	VODKO	MAVD...R		EMASD...
 EKI Sealing Ring	27	DKI	DKI	DKRI	080..	DKR

Weld Fittings

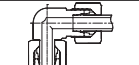
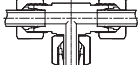
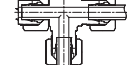
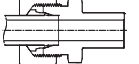
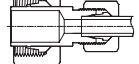

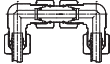
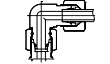
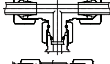
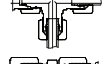

 EAS Weld Connector	28	AS	V	GAS-V	139..	P-ASV
 EAK Weld Nipple with O-Ring	28	SKA	SNO	SK-A..OD	070..	SN
 EASK Weld Connector with EAK	29	ASK	ESNO	ASKK..OD		
 EAKR Reducing Weld Nipple with O-Ring	29	SKAR	SNR			
Welding information	30					

Adjustable Standpipe Fittings





 ELA Adjustable Standpipe Elbow	31	EWV	VB	EW-V	158..	P-EWV-SV
 EBTA Adjustable Standpipe Branch Tee	31	EVT	VC	ET-V	160..	P-ETV-SV
 ERTA Adjustable Standpipe Run Tee	32	EVL	VD	EL-V	162..	P-ELV-SV
 ER Reducer	33	KOR		KOR-V	148..78	P-REDV-SV
 EKOR Adjustable Standpipe Reducer	34	KOR	RL,RS			
 EA-GE/ME Adjustable Standpipe Male Adaptor (BSPP / Metric Parallel)	35	EVGE-..R-ED ..M-ED	VA-..RWD ..MWD	EG-V..RWD ...MWD	177... 174...	P-EGES.. R-WD-SV M-WD-SV

Adjustable Swivel Fittings		Page	EO	EMB	VOLZ	VOSS	WALPRO
	EUE Adjustable Swivel Union	36	GE	EDKO	EDKV		SNV
	EEW Adjustable Swivel Elbow	37	EW	VBDKO	EWWD		P-EWWD
	EET Adjustable Swivel Branch Tee	37	ET	VCDKO	ETVD		P-ETVD
	EEL Adjustable Swivel Run Tee	38	EL	VDDKO	ELVD		P-ELVD
	ERED Adjustable Swivel Reducer	39	RED	RLDKO RSDKO	REDV		P-REDVD
	EEGE-GE/ME Adjustable Swivel Male Adaptor (BSPP / Metric Parallel)	40	EGE-...R-ED ...M-ED	VADKO -RWD -MWD	EGVD ..RWD ..MWD		EGESD.. ..R-WD ..M-WD





Plug and Caps

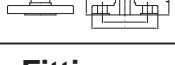

	EVSTI-GE/ME Blanking Plugs with ED-ring	41	VSIT R-ED ...M-ED	VSCH-...RWD ...MWD	VSCH..WD	189..	
	EVSTI-MF Blanking Plugs with O-ring	41	VSIT M-OR				
	EVKA Tube Port Plugs with O-ring	42	VKA	STO-O	VSTO..OD		VS..
	ECA Tube Cap	42	ROV	VSCHK	EVSV		

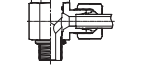
Adapter

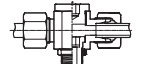





	EMFAD-GB Male Female Adapter (BSPP Parallel)	43	RI	RI	RIAS	149.....	RED
	EMFAE-GB Male Female Adapter (BSPP Parallel)	43	RI	RI	RIBS	149.....	RED
	EMFAD-GE Male Female Adapter (BSPP Parallel)	44	RI-ED	RI-WD	RIAS..WD		RED...WD
	EMFAE-GE Male Female Adapter (BSPP Parallel)	44	RI-ED	RI-WD	RIBS..WD		RED...WD
	EF Flange Adapters	45					

Banjo Fittings

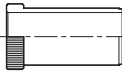
	EBA-G/M Banjo Fitting (BSPP / Metric Parallel)	46	SWVE-R -M	SBD-R -M		152../153.. 150../151..	
	EBAH-G/M High Pressure Banjo Fitting (BSPP / Metric Parallel)	47	WH-R -M	SBE-R -M	EWHV-..R -..M	157.. 155..	P-RSWV..R ..M
	EBTH-G/M Tee High Pressure Banjo Fitting (BSPP / Metric Parallel)	48	TH-R -M	SGE-R -M	ETHV-...R -...M		P-RSTV..R ..V
	EBAT-G/M Throttle-Free Banjo Fitting (BSPP / Metric Parallel)	49	DSVW-R -M	SB-R -B			
	EBTT-G/M Tee Throttle-Free Banjo Fitting (BSPP / Metric Parallel)	50	DSVT-R -M	SG-R -M			
	EKA Sealing Ring for EBA/EBAH/EBTH	51	DKA	DKA	DKRA	080...	
	EKAZ Sealing Ring for EBAT/EBTT	51	DKAZ	DKAD		081..	

Test Coupling	Page	EO	EMB	VOLZ	VOSS	WALPRO
 EEMA3 Test Coupling with M16 Connection	52	EMA3				
	 EEMA3T Tee Test Coupling with M16 Connection	52	GMA3			

Spare Part & Tool

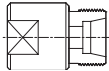
	EIL Tube insert	53	VH	VSH	VS-H	020..	EH
	ELN Bulkhead Lock Nut	53	GM	GM	G-M	080...	
	9PE ED-RING	54	ED		WD-R		
	9PO O-RING	54	OR		OD-R		
	EN Nut	55	M	M	U-M	004	M
	ES Cutting Ring	55	DPR	S	S-DR	007..	S-R P-R
	Tube Port Dimension	55					
	EKV Manual Pre-Assembly Tool	56					

Ball Valves

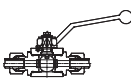
	Ball Valve Information	56					
	VBE-Series Ball Valves	57-58	KH...				P-KHV

Non Return Valves

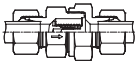
	Non-Return Valve Information	59					
	VCE-L/S Non Return Valves	60	RHD	RD	RS-V	600..	P-RV
	VCE-F Non Return Valves	60					
	VCE L/S-GE/ME Non Return Valves	61					
	VCE GE/ME-L/S Non Return Valves	62					

Fitting Assembly Instruction	63,64					
-------------------------------------	-------	--	--	--	--	--

Standards and Interchangeability

HSME's DIN Type Tube Fittings conform to the design requirements of ISO 8434-1, DIN 2353, and DIN EN 3851 standards. This ensures the interchangeability with other leading brands.



The fitting consists of Body, Cutting ring, and Nut as shown in the picture.

Raw Materials

HSME's quality control starts with the best selection of right raw materials for fitting construction.

Stainless Steel 316

Material Designator: SS

ASTM	DIN
ASTM A276 Type 316 ASTM A182 F316	X6CrNiMoTi 17-12-2 to DIN17440, Material No. 1.4571

Steel

Material Designator: C

ASTM / JIS	DIN
ASTM A108 / A105 JIS G4051 S20C -S45C/ G3201 SF440A	DIN1651 / 9SMn28K

Brass

Material Designator: B

ASTM / JIS	DIN
ASTM B16 UNS C36000 ASTM B282 Alloy 37700 JIS H3250 C3604, C3771 JIS H3250 C3771	CUZN35Ni2 to DIN17660/17672, Material No. 2.0540

Pressure and Temperature Load Capability

Nominal Pressure – PN

The pressures specified in our catalog are related to **PN** (Nominal Pressure) according to DIN 2401 part 1 draft. The pressure has a safety factor of 4 times according to DIN 3859.

Allowable Working Pressure - PB

The pressure of PB is specified in our catalog where PN is not specified. The safety factor of the pressure is 1.5 or 2.5 times.

Allowable Working Temperature - TB

Fitting Materials

Material	Working Temperature
Stainless Steel	-60 °C to +400 °C
Steel	-40 °C to +120 °C
Brass	-60 °C to +175 °C

Seal Materials

Designator	Material	Working Temperature
BN	NBR	-35 °C to +100 °C
VT	FKM	-25 °C to +200 °C
TE	PTFE	-60 °C to +240 °C

- HSME's standard seal material is NBR

Pressure Range

- Stainless Steel
- Steel

Series	Pressure
LL	Up to 100 bar
L	Up to 500 bar
S	Up to 800 bar

Pressure Reduction at Elevated Temperature

In operation the pressure reduction caused by the temperature of the fluid medium has to be taken into account.

Fitting Material	Temperature Range	Pressure Reduction
Stainless Steel	-60 °C to +20 °C	-
	-60 °C to +50 °C	4%
	+100 °C	11%
	+200 °C	20%
	+300 °C	29%
Steel	+400 °C	33%
	-40 °C to +120 °C	-
Brass	-60 °C to +175 °C	35%

Hydraulic DIN Type Tube Fittings

The hydraulic tube fittings are designed for use with the fluid of commercial hydraulic oils.

Fitting Cleaning and Surface Protection

Fittings are cleaned to remove surface contamination, loose particles, iron particles out of cutting tools, and oil from cutting fluid.

After fittings are cleaned, additional process to protect fittings from corrosion takes place.

- Stainless Steel : Passivation
- Steel : White Zinc Electroplated with Chrome VI free, Optional Zinc Nickel Plating
- Brass : Acid Cleaning

Weld Fittings

The body of steel weld fitting is phosphated. SS316L body is supplied for stainless steel weld fitting.

Dimensions

Dimensions in this catalog are millimeter unless otherwise specified.

Forms of Stud Ends

DIN 3852 Part 1 + 2 specifies the dimensions of stud ends and tapped holes for metric fine pitch thread and pipe thread applicable to compression fittings, valves and screw plugs.

Thread size		d3	d4 _{-0.2}	d5±0.1
Form A,B and E,F stud ends d1	Form C stud ends d2			
M 8 x 1.0	M 8 x 1.0 keg.	-	-	10.9
M10 x 1.0	M10 x 1.0 keg.	14	13.9	12.9
M12 x 1.5	M12 x 1.5 keg.	17	16.9	16.9
M14 x 1.5	M14 x 1.5 keg.	19	18.9	18.9
M16 x 1.5	M16 x 1.5 keg.	21	21.9	20.9
M18 x 1.5	M18 x 1.5 keg.	23	23.9	22.9
M20 x 1.5	M20 x 1.5 keg.	25	25.9	24.9
M22 x 1.5	M22 x 1.5 keg.	27	26.9	26.9
M26 x 1.5	-	31	31.9	30.9
M27 x 2.0	-	32	31.9	31.9
M33 x 2.0	-	39	39.9	37.9
M42 x 2.0	-	49	49.9	47.9
M48 x 2.0	-	55	54.9	54.9
G 1/8	1/8 NPT	14	13.9	-
G 1/4	1/4 NPT	18	18.9	-
G 3/8	3/8 NPT	22	21.9	-
G 1/2	1/2 NPT	26	26.9	-
G 3/4	3/4 NPT	32	31.9	-
G 1	1 NPT	39	39.9	-
G 1 1/4	1 1/4 NPT	49	49.9	-
G 1 1/2	1 1/2 NPT	55	54.9	-
7/16 – 20UNF	R 1/8 keg.	-	-	14.4
9/16 – 18UNF	R 1/4 keg.	-	-	17.6
3/4 – 16UNF	R 3/8 keg.	-	-	22.3
7/8 – 14UNF	R 1/2 keg.	-	-	25.5
1 1/16 – 12UN	R 3/4 keg.	-	-	31.9
1 5/16 - 12UN	R 1 keg.	-	-	38.2
1 5/8 – 12UN	R 1 1/4 keg.	-	-	47.7
-	R 1 1/2 keg.	-	-	-

Form A (DIN 3852 Part 1+2) sealing by washer

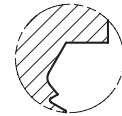
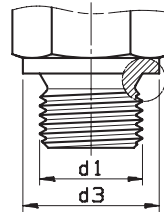

Sectional View

Form B (DIN 3852 Part 1+2) sealing by compression against face of body

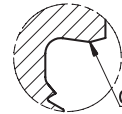
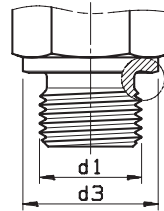

Sectional View

Form C (DIN 3852 Part 1+2) sealing by tapered thread

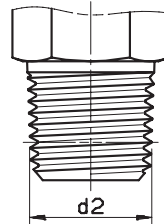

Metric (keg) DIN 158
B.S.P (keg) DIN 2999
NPT (keg) ANSI / ASME B1.20.1-1983

Form E (DIN 3852 Part 11) sealing by DIN 3869 ring seals

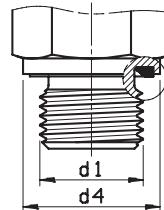

Sectional View

Form F (DIN 3852 Part 3) sealing by O-ring

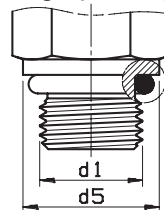

Sectional View

Note:

Parallel thread fittings are supplied with standard "Form A" Stud End if a specific "Form of Stud End" is not specified in your ordering number

Forms of Tapped Holes

Form X (DIN 3852 Part 1+2)
for parallel Stud Ends. (Form A,B)
*d7 is for Stud Ends Form E

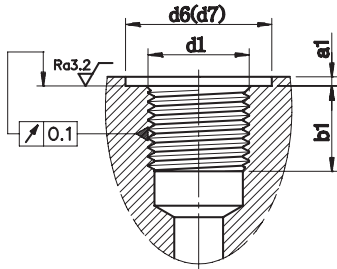

Form W (DIN 3852 Part 3)
for Stud Ends with O-Ring. (Form F)

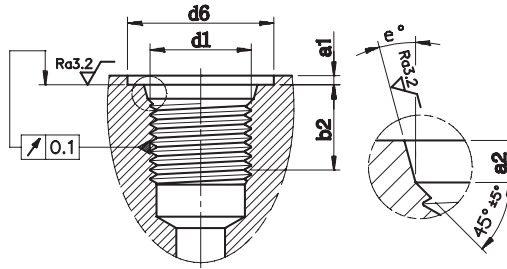

Form Z (DIN 3852 Part 1+2)
for tapered thread Stud Ends

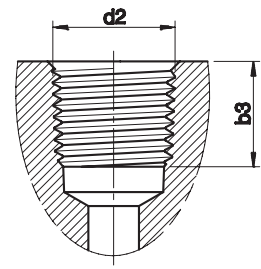

Thread size		d6 min	d7	a6 max	a2	b1 min	b2 min	b3 min	e°±1°
Form X.W Tapped Holes d1	Form Z Tapped Holes d2								
M 8 x 1.0	M 8 x 1.0 keg.	13	-	1.0	1.6	-	10.0	5.5	12
M10 x 1.0	M10 x 1.0 keg.	15	15	1.0	1.6	8	10.0	5.5	12
M12 x 1.5	M12 x 1.5 keg.	18	18	1.5	2.4	12	11.5	8.5	12
M14 x 1.5	M14 x 1.5 keg.	20	20	1.5	2.4	12	11.5	8.5	15
M16 x 1.5	M16 x 1.5 keg.	22	23	1.5	2.4	12	13.0	8.5	15
M18 x 1.5	M18 x 1.5 keg.	24	25	2.0	2.4	12	14.5	8.5	15
M20 x 1.5	M20 x 1.5 keg.	26	27	2.0	2.4	14	14.0	10.5	15
M22 x 1.5	M22 x 1.5 keg.	28	28	2.5	2.4	14	15.5	10.5	15
M26 x 1.5	-	32	33	2.5	3.1	16	16.0	-	15
M27 x 2.0	-	33	33	2.5	3.1	16	19.0	-	15
M33 x 2.0	-	40	41	2.5	3.1	18	19.0	-	15
M42 x 2.0	-	50	51	2.5	3.1	20	19.5	-	15
M48 x 2.0	-	56	56	2.5	3.1	22	22	-	15
G 1/8	1/8 NPT	15	15	1.0	-	8	-	6.9	-
G 1/4	1/4 NPT	19	20	1.5	-	12	-	10.0	-
G 3/8	3/8 NPT	23	23	2.0	-	12	-	10.3	-
G 1/2	1/2 NPT	27	28	2.5	-	14	-	13.6	-
G 3/4	3/4 NPT	33	33	2.5	-	16	-	14.1	-
G 1	1 NPT	40	41	2.5	-	18	-	16.8	-
G 1 1/4	1 1/4 NPT	50	51	2.5	-	20	-	17.3	-
G 1 1/2	1 1/2 NPT	56	56	2.5	-	22	-	17.3	-
7/16 – 20UNF	R 1/8 keg.	21	-	1.6	2.4	-	11.5	5.5	12
9/16 – 18UNF	R 1/4 keg.	25	-	1.6	2.5	-	12.7	8.5	12
3/4 – 16UNF	R 3/8 keg.	30	-	2.4	2.5	-	14.3	8.5	15
7/8 – 14UNF	R 1/2 keg.	34	-	2.4	2.5	-	16.7	10.5	15
1 1/16 – 12UN	R 3/4 keg.	41	-	2.4	3.3	-	19.0	13.0	15
1 5/16 - 12UN	R 1 keg.	49	-	3.2	3.3	-	19.0	16.0	15
1 5/8 – 12UN	R 1 1/4 keg	58	-	3.2	3.3	-	19.0	17.0	15
-	R 1 1/2 keg			-	-	-	-	17.0	-

Tightening Torques for Studs

Parallel BSPP & Metric Threads

- The torque values here are for white zinc steel fittings.
- The male studs are lubricated with hydraulic oil before screwed in.

Unit: Nm

BSPP Straight Ports			Straight Male Stud Fittings with port tapping					Adjustable Ends		Blanking Plugs		Non- Return Valves
Series	Tube O.D	Thread Size	Form A sealing by washer	Form B against face	Form E ED sealing	Form F O-ring	O-ring with retaining ring	O-ring and retaining ring	O-ring	EVSTI with ED sealing	VCE with ED sealing	
L	6	G 1/8	9	18	18	18	18	18	18	13	18	
	8	G 1/4	35	35	35	35	35	35	35	30	35	
	10	G 1/4	35	35	35	35	35	35	35	-	35	
	12	G 3/8	45	70	70	70	70	70	70	60	50	
	15	G 1/2	65	140	140	90	90	110	110	80	85	
	18	G 1/2	65	100	100	90	90	110	110	-	65	
	22	G 3/4	90	180	180	180	180	180	180	140	140	
	28	G 1	150	330	330	310	310	310	310	200	190	
	35	G 1 1/4	240	540	540	450	450	450	450	400	360	
42	G 1 1/2	290	630	630	540	540	540	540	450	540		
S	6	G 1/4	35	55	40	40	-	55	55	-	45	
	8	G 1/4	35	55	40	40	-	55	55	-	45	
	10	G 3/8	45	90	80	80	-	90	90	-	60	
	12	G 3/8	45	90	80	80	-	90	90	-	60	
	14	G 1/2	65	150	115	115	-	110	110	-	145	
	16	G 1/2	65	130	115	115	-	110	110	-	100	
	20	G 3/4	90	270	180	180	-	115	115	-	145	
	25	G 1	150	340	310	310	-	420	420	-	260	
	30	G 1 1/4	240	540	450	450	-	550	550	-	360	
38	G 1 1/2	290	700	540	540	-	600	600	-	540		

Unit: Nm

Metric Straight Ports			Straight Male Stud Fittings with port tapping					Adjustable Ends		Blanking Plugs		Non- Return Valves
Series	Tube O.D	Thread Size	Form A sealing by washer	Form B against face	Form E ED sealing	Form F O-ring	O-ring with retaining ring	O-ring and retaining ring	O-ring	EVSTI with ED sealing	EVSTI with O-ring	VCE with ED sealing
L	6	M10x1.0	9	18	18	15	18	18	15	12	20	18
	8	M12x1.5	20	30	25	25	35	35	25	25	-	25
	10	M14x1.5	35	45	45	35	45	45	35	35	-	35
	12	M16x1.5	45	65	55	40	55	55	40	50	-	50
	15	M18x1.5	55	80	70	45	70	70	45	65	-	70
	18	M22x1.5	65	140	125	60	160	180	60	90	-	125
	22	M26x2.0	90	190	180	100	250	180	100	135	-	145
	28	M33x2.0	150	340	310	160	310	310	160	225	-	210
	35	M42x2.0	240	500	450	210	450	450	210	360	-	360
42	M48x2.0	290	630	540	260	540	600	260	360	-	540	
S	6	M12x1.5	20	35	40	35	-	35	35	-	35	35
	8	M14x1.5	35	55	40	45	-	60	45	-	45	45
	10	M16x1.5	45	70	70	55	-	95	55	-	55	55
	12	M18x1.5	55	110	90	70	-	120	90	-	70	70
	14	M20x1.5	55	150	125	80	-	-	-	80	80	100
	16	M22x1.5	65	170	135	100	-	190	100	-	100	125
	20	M27x2.0	90	270	180	170	-	190	170	-	170	135
	25	M33x2.0	150	410	310	310	-	500	310	-	310	210
	30	M42x2.0	240	540	450	330	-	600	330	-	330	360
38	M48x2.0	290	700	540	420	-	600	420	-	420	540	

Ordering Information

Tube O.D. Designator

O.D.	4mm	6mm	8mm	38mm	42mm
Designator	04	06	08	38	42

DIN Fitting Series Designator

Series	Very Light	Light	Heavy
Designator	LL	L	S

To order, select a part number in this catalog, and suffix the applicable material designator.

Material Designator

Material	SS316/SS316L	Brass	Carbon Steel	
			"White Zinc Electroplated with Chrome VI free" plating designator	Optional "Zinc Nickel Plating" Designator
Body, Cutting Ring, and Nut only Designator	-SS	-B	-C	-CZN
Complete Fitting Assembly Designator	-SSA	-BA	-CA	-CZNA

Examples:

EU-08S-SS	Order number for body only.
EN-08S-SS	Order number for nut only.
ES-08S-SS	Order number for cutting ring only.
EU-08S-SSA	Order number for complete fitting assembly.

Metric Thread Size Designator

Standard	Thread	Metric Size						
		M8 x 1.0	M10 x 1.0	M12 x 1.5	M14 x 1.5	M42 x 2.0	M48 x 2.0
DIN-13	Parallel	8M	10M	12M	14M	42M	48M
DIN 158	Taper (Keg)	8MK	10MK	12MK	14MK	42MK	48MK

Unified Thread Designator

Size	7/16-20UNF	9/16-18UNF	3/4-16UNF	7/8-14UNF	1 1/16-12UN	1 5/16-12UN	1 5/8-12UN
Designator	04U	06U	08U	10U	12U	16U	20U

Pipe Thread Designator

Designator	Symbol	Thread	Standard
N	NPT	Tapered Pipe Thread	ANSI/ASME B1.20.1
R	BSPT, PT	Tapered Pipe Thread	ISO 7-1, DIN 2999, BS21(BSPT), JIS B0203 (PT)
G	BSPP, PF	Parallel Pipe Thread	ISO 228-1, DIN 259, BS 2779 (BSPP), JIS B0202 (PF)

Pipe Size Designator

Pipe Thread Designator	Pipe Nominal Size							
	1/8"	1/4"	3/8"	1/2"	3/4"	1"	1 1/4"	1 1/2"
N	01N	02N	03N	04N	06N	08N	10N	12N
R	01R	02R	03R	04R	06R	08R	10R	12R
G	01G	02G	03G	04G	06G	08G	10G	12G

• Straight Union

EU

Connects Tubes

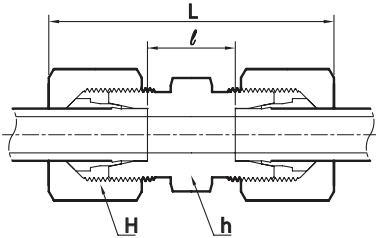

Series	Part No.	Tube O.D.	H	h	L	ℓ
LL PN 100	EU-04LL	4	10	9	31	12
	EU-06LL	6	12	11	32	9
	EU-08LL	8	14	12	35	12
	EU-10LL	10	17	14	35	12
	EU-12LL	12	19	17	35	11
L PN 315	EU-06L	6	14	12	39	10
	EU-08L	8	17	14	40	11
	EU-10L	10	19	17	42	13
	EU-12L	12	22	19	43	14
	EU-15L	15	27	24	46	16
PN 160	EU-18L	18	32	27	48	16
	EU-22L	22	36	32	52	20
	EU-28L	28	41	41	54	21
	EU-35L	35	50	46	63	20
S PN 630	EU-42L	42	60	55	66	21
	EU-06S	6	17	14	45	16
	EU-08S	8	19	17	47	18
	EU-10S	10	22	19	49	17
	EU-12S	12	24	22	51	19
PN 400	EU-14S	14	27	24	57	22
	EU-16S	16	30	27	57	21
	EU-20S	20	36	32	66	23
	EU-25S	25	46	41	74	26
PN 315	EU-30S	30	50	46	80	27
	EU-38S	38	60	55	90	29

• Bulkhead Union

EBU

Connects Tubes

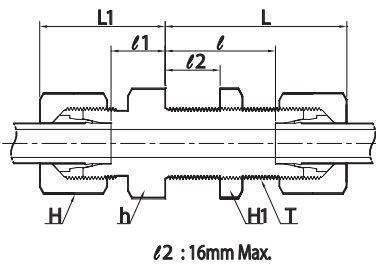

Series	Part No.	Tube O.D.	H	H1	h	L	L1	ℓ	ℓ1	T
L PN 315	EBU-06L	6	14	17	17	42	22	27	7	M12x1.5
	EBU-08L	8	17	19	19	42	23	27	8	M14x1.5
	EBU-10L	10	19	22	22	43	25	28	10	M16x1.5
	EBU-12L	12	22	24	24	44	25	29	10	M18x1.5
	EBU-15L	15	27	30	27	46	27	31	12	M22x1.5
	EBU-18L	18	32	36	32	49	30	32.5	13.5	M26x1.5
PN 160	EBU-22L	22	36	41	36	51	33	34.5	16.5	M30x2
	EBU-28L	28	41	46	41	52	35	35.5	18.5	M36x2
	EBU-35L	35	50	55	50	58	40	36.5	18.5	M45x2
	EBU-42L	42	60	65	60	59	42	36	19	M52x2
S PN 630	EBU-06S	6	17	19	19	44	27	29	12	M14x1.5
	EBU-08S	8	19	22	22	44	28	29	13	M16x1.5
	EBU-10S	10	22	24	24	46	31	29.5	14.5	M18x1.5
	EBU-12S	12	24	27	27	47	31	30.5	14.5	M20x1.5
	EBU-14S	14	27	30	30	50	35	32	17	M22x1.5
PN 400	EBU-16S	16	30	32	32	50	35	31.5	16.5	M24x1.5
	EBU-20S	20	36	41	41	55	39	33.5	17.5	M30x2
	EBU-25S	25	46	46	46	59	44	35	20	M36x2
	EBU-30S	30	50	50	50	64	48	37.5	21.5	M42x2
PN 315	EBU-38S	38	60	65	65	68	53	37	22	M52x2

DIN 2353 Tube Fittings

Weld Bulkhead Union

EBUW

Connects Tubes

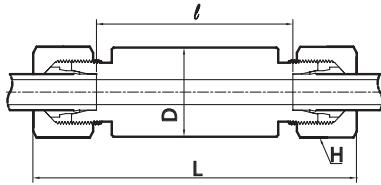

Series	Part No.	Tube O.D.	D	H	L	ℓ
L PN 315	EBUW-06L	6	18	14	85	56
	EBUW-08L	8	20	17	85	56
	EBUW-10L	10	22	19	87	58
	EBUW-12L	12	25	22	87	58
	EBUW-15L	15	28	27	100	70
	EBUW-18L	18	32	32	101	69
PN 160	EBUW-22L	22	36	36	105	73
	EBUW-28L	28	40	41	106	73
	EBUW-35L	35	50	50	114	71
	EBUW-42L	42	60	60	115	70
S PN 630	EBUW-06S	6	20	17	89	60
	EBUW-08S	8	22	19	89	60
	EBUW-10S	10	25	22	91	59
	EBUW-12S	12	28	24	91	59
	EBUW-14S	14	30	27	107	72
PN 400	EBUW-16S	16	35	30	107	71
	EBUW-20S	20	38	36	114	71
	EBUW-25S	25	45	46	120	72
	EBUW-30S	30	50	50	126	73
PN 315	EBUW-38S	38	60	60	133	72

• Reducing Union

EUR

Connects Tubes

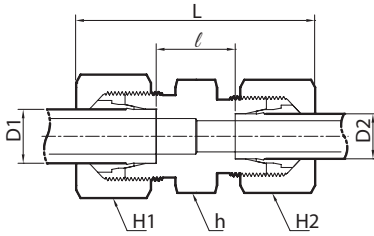

Series	Part No.	Tube O.D.		H1	H2	h	L	ℓ
		D1	D2					
L PN 315	EUR 08L-06L	8	6	17	14	14	40	11.0
	EUR 10L-06L	10	6	19	14	17	41	12.0
	EUR 10L-08L	10	8	19	17	17	41	12.0
	EUR 12L-06L	12	6	22	14	19	42	13.0
	EUR 12L-08L	12	8	22	17	19	42	13.0
	EUR 12L-10L	12	10	22	19	19	43	14.0
	EUR 15L-10L	15	10	27	19	24	45	15.0
	EUR 15L-12L	15	12	27	22	24	45	15.0
	EUR 18L-10L	18	10	32	19	27	46	15.5
	EUR 18L-12L	18	12	32	22	27	46	15.5
	EUR 18L-15L	18	15	32	27	27	48	16.5
PN 160	EUR 22L-12L	22	12	36	22	32	48	17.5
	EUR 22L-15L	22	15	36	27	32	50	18.5
	EUR 22L-18L	22	18	36	32	32	50	18.0
	EUR 28L-18L	28	18	41	32	41	52	19.0
	EUR 28L-22L	28	22	41	36	41	54	21.0
	EUR 35L-22L	35	22	50	36	46	59	21.0
	EUR 35L-28L	35	28	50	41	46	59	21.0
S PN 630	EUR 08S-06S	8	6	19	17	17	47	18.0
	EUR 10S-06S	10	6	22	17	19	48	17.5
	EUR 10S-08S	10	8	22	19	19	48	17.5
	EUR 12S-06S	12	6	24	17	22	50	19.5
	EUR 12S-08S	12	8	24	19	22	50	19.5
	EUR 14S-10S	12	10	24	22	22	51	19.0
	EUR 14S-10S	14	10	27	22	24	54	20.5
EUR 14S-12S	14	12	27	24	24	54	20.5	
S PN 400	EUR 16S-12S	16	12	30	24	27	54	20.0
	EUR 16S-14S	16	14	30	27	27	57	21.5
	EUR 20S-10S	20	10	36	22	32	60	22.0
	EUR 20S-12S	20	12	36	24	32	60	22.0
	EUR 20S-16S	20	16	36	30	32	63	23.0
	EUR 25S-16S	25	16	46	30	41	68	25.0
	EUR 25S-20S	25	20	46	36	41	71	25.5
EUR 30S-20S	30	20	50	36	46	74	26.0	
EUR 30S-25S	30	25	50	46	46	77	26.5	
PN 315	EUR 38S-30S	38	30	60	50	55	87	29.5

Union Elbow

EL

Connects Tubes

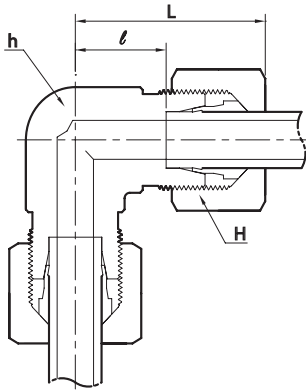

Series	Part No.	Tube O.D.	H	h	L	ℓ
LL PN 100	EL-04LL	4	10	9	21	11.0
	EL-06LL	6	12	9	21	9.5
	EL-08LL	8	14	12	23	11.5
	EL-10LL	10	17	14	24	12.5
	EL-12LL	12	19	17	25	13.0
L PN 315	EL-06L	6	14	12	27	12.0
	EL-08L	8	17	12	29	14.0
	EL-10L	10	19	14	30	15.0
	EL-12L	12	22	17	32	17.0
	EL-15L	15	27	19	36	21.0
PN 160	EL-18L	18	32	24	40	23.5
	EL-22L	22	36	27	44	27.5
	EL-28L	28	41	36	47	30.5
	EL-35L	35	50	41	56	34.5
S PN 630	EL-42L	42	60	50	63	40.0
	EL-06S	6	17	12	31	16.0
	EL-08S	8	19	14	32	17.0
	EL-10S	10	22	17	34	17.5
	EL-12S	12	24	17	38	21.5
PN 400	EL-14S	14	27	19	40	22.0
	EL-16S	16	30	24	43	24.5
	EL-20S	20	36	27	48	26.5
	EL-25S	25	46	36	54	30.0
PN 315	EL-30S	30	50	41	62	35.5
	EL-38S	38	60	50	72	41.0

• Bulkhead Union Elbow

EBL

Connects Tubes

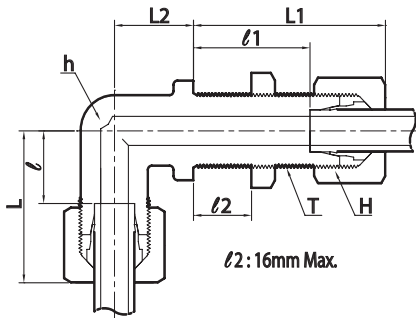

Series	Part No.	Tube O.D.	H	H1	h	L	L1	L2	ℓ	ℓ1	T
L PN 315	EBL-06L	6	14	17	12	27	42	14	12	27.0	M12x1.5
	EBL-08L	8	17	19	12	29	42	17	14	27.0	M14x1.5
	EBL-10L	10	19	22	14	30	43	18	15	28.0	M16x1.5
	EBL-12L	12	22	24	17	32	44	20	17	29.0	M18x1.5
	EBL-15L	15	27	30	19	36	46	23	21	31.0	M22x1.5
PN 160	EBL-18L	18	32	36	24	40	49	24	23.5	32.5	M26x1.5
	EBL-22L	22	36	41	27	44	51	30	27.5	34.5	M30x2
	EBL-28L	28	41	46	36	47	52	34	30.5	35.5	M36x2
	EBL-35L	35	50	55	41	56	58	39	34.5	36.5	M45x2
S PN 630	EBL-42L	42	60	65	50	63	59	43	40	36.0	M52x2
	EBL-06S	6	17	19	12	31	44	17	16	29.0	M14x1.5
	EBL-08S	8	19	22	14	32	44	18	17	29.0	M16x1.5
	EBL-10S	10	22	24	17	34	46	20	17.5	29.5	M18x1.5
	EBL-12S	12	24	27	17	38	47	21	21.5	30.5	M20x1.5
PN 400	EBL-14S	14	27	30	19	40	50	23	22	32.0	M22x1.5
	EBL-16S	16	30	32	24	43	50	24	24.5	31.5	M24x1.5
	EBL-20S	20	36	41	27	48	55	30	26.5	33.5	M30x2
	EBL-25S	25	46	46	36	54	59	34	30	35.0	M36x2
PN 315	EBL-30S	30	50	50	41	62	64	39	35.5	37.5	M42x2
PN 315	EBL-38S	38	60	65	50	72	68	43	41	37.0	M52x2

• Union Tee

ET

Connects Tubes

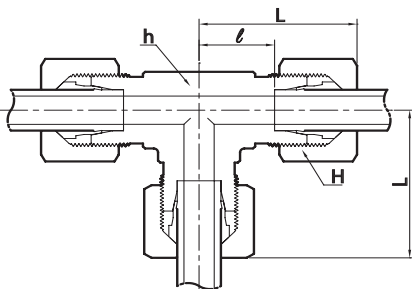

Series	Part No.	Tube O.D.	H	h	L	ℓ
LL PN 100	ET-04LL	4	10	9	21	11.0
	ET-06LL	6	12	9	21	9.5
	ET-08LL	8	14	12	23	11.5
	ET-10LL	10	17	14	24	12.5
	ET-12LL	12	19	14	27	15.0
L PN 315	ET-06L	6	14	12	27	12.0
	ET-08L	8	17	12	29	14.0
	ET-10L	10	19	14	30	15.0
	ET-12L	12	22	17	32	17.0
	ET-15L	15	27	19	36	21.0
PN 160	ET-18L	18	32	24	40	23.5
	ET-22L	22	36	27	44	27.5
	ET-28L	28	41	36	47	30.5
	ET-35L	35	50	41	56	34.5
S PN 630	ET-42L	42	60	50	63	40.0
	ET-06S	6	17	12	31	16.0
	ET-08S	8	19	14	32	17.0
	ET-10S	10	22	17	34	17.5
	ET-12S	12	24	17	38	21.5
PN 400	ET-14S	14	27	19	40	22.0
	ET-16S	16	30	24	43	24.5
	ET-20S	20	36	27	48	26.5
	ET-25S	25	46	36	54	30.0
PN 315	ET-30S	30	50	41	62	35.5
PN 315	ET-38S	38	60	50	72	41.0

DIN 2353 Tube Fittings

Reducing Tee

ETR

Connects Tubes

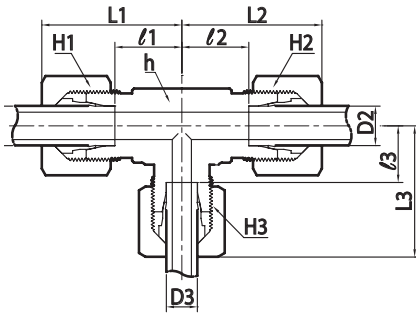

Series	Part No.	Tube O.D.			H1	H2	H3	h	L1	L2	L3	ℓ1	ℓ2	ℓ3
		D1	D2	D3										
L PN 315	ETR06L-06L-08L	6	6	8	14	14	17	14	29	29	29	14.0	14.0	14.0
	ETR08L-08L-06L	8	8	6	17	17	14	14	29	29	29	14.0	14.0	14.0
	ETR06L-06L-10L	6	6	10	14	14	19	14	30	30	30	15.0	15.0	15.0
	ETR08L-08L-10L	8	8	10	17	17	19	14	30	30	30	15.0	15.0	15.0
	ETR10L-10L-06L	10	10	6	19	19	14	14	30	30	30	15.0	15.0	15.0
	ETR10L-10L-08L	10	10	8	19	19	17	14	30	30	30	15.0	15.0	15.0
	ETR10L-06L-10L	10	6	10	14	14	19	14	30	30	30	15.0	15.0	15.0
	ETR08L-08L-12L	8	8	12	17	17	22	17	32	32	32	17.0	17.0	17.0
	ETR12L-12L-06L	12	12	6	22	22	14	17	32	32	32	17.0	17.0	17.0
	ETR12L-08L-08L	12	8	8	17	17	17	17	32	32	32	17.0	17.0	17.0
	ETR12L-12L-08L	12	12	8	22	22	17	17	32	32	32	17.0	17.0	17.0
	ETR12L-10L-10L	12	10	10	19	19	19	17	32	32	32	17.0	17.0	17.0
	ETR12L-12L-10L	12	12	10	22	22	19	17	32	32	32	17.0	17.0	17.0
	ETR12L-10L-12L	12	10	12	19	19	22	17	32	32	32	17.0	17.0	17.0
	ETR10L-10L-15L	10	10	15	19	19	27	19	36	36	36	17.0	17.0	17.0
	ETR12L-12L-15L	12	12	15	22	22	27	19	36	36	36	21.0	21.0	21.0
	ETR15L-15L-06L	15	15	6	27	27	14	19	36	36	36	21.0	21.0	21.0
	ETR15L-15L-10L	15	15	10	27	27	19	19	36	36	36	21.0	21.0	21.0
	ETR15L-12L-12L	15	12	12	22	22	22	19	36	36	36	21.0	21.0	21.0
	ETR15L-15L-12L	15	15	12	27	27	22	19	36	36	36	21.0	21.0	21.0
	ETR15L-12L-15L	15	12	15	22	22	27	19	36	36	36	21.0	21.0	21.0
	ETR12L-12L-18L	12	12	18	22	22	32	24	39	39	40	24.0	24.0	23.5
	ETR18L-10L-10L	18	10	10	19	19	19	24	40	39	39	23.5	24.0	24.0
	ETR18L-18L-10L	18	18	10	32	32	19	24	40	40	39	23.5	23.5	24.0
	ETR18L-18L-12L	18	18	12	32	32	22	24	40	40	39	23.5	23.5	24.0
	ETR18L-18L-15L	18	18	15	32	32	27	24	40	40	39	23.5	23.5	24.0
	ETR18L-10L-18L	18	10	18	19	19	32	24	40	39	40	23.5	24.0	24.0
PN 160	ETR22L-22L-10L	22	22	10	36	36	19	27	44	44	43	27.5	27.5	23.5
	ETR22L-22L-12L	22	22	12	36	36	22	27	44	44	43	27.5	27.5	28.0
	ETR22L-15L-15L	22	15	15	27	27	27	27	44	43	43	27.5	28.0	28.0
	ETR22L-22L-15L	22	22	15	36	36	27	27	44	44	43	27.5	27.5	28.0
	ETR22L-18L-18L	22	18	18	32	32	32	27	44	44	44	27.5	27.5	28.0
	ETR22L-22L-18L	22	22	18	36	36	32	27	44	44	44	27.5	27.5	27.5
	ETR22L-18L-22L	22	18	22	32	32	36	27	44	44	44	27.5	27.5	27.5
	ETR28L-28L-10L	28	28	10	41	41	19	36	47	44	46	30.5	30.5	31.0
	ETR28L-28L-12L	28	28	12	41	41	22	36	47	47	46	30.5	30.5	31.0
	ETR28L-28L-15L	28	28	15	41	41	27	36	47	47	46	30.5	30.5	31.0
S PN 630	ETR28L-28L-18L	28	28	18	41	41	32	36	47	47	47	30.5	30.5	30.5
	ETR28L-22L-22L	28	22	22	41	36	36	47	47	47	30.5	30.5	30.5	
	ETR28L-28L-22L	28	28	22	41	41	36	47	47	47	30.5	30.5	30.5	
	ETR10S-10S-06S	10	10	6	22	22	17	17	34	34	33	17.5	17.5	18.0
	ETR12S-08S-08S	12	8	8	24	19	19	17	38	37	37	21.5	22.0	22.0
	ETR12S-12S-08S	12	12	8	24	24	19	17	38	38	37	21.5	21.5	22.0
	ETR12S-12S-10S	12	12	10	24	24	22	17	38	38	38	21.5	21.5	21.5
	ETR12S-12S-16S	12	12	16	24	24	30	24	42	42	43	25.5	25.5	24.5
	ETR16S-16S-06S	16	16	6	30	30	17	24	43	43	41	24.5	24.5	26.0
	ETR16S-16S-08S	16	16	8	30	30	19	24	43	43	41	24.5	24.5	26.0
PN 400	ETR16S-16S-10S	16	16	10	30	30	22	24	43	43	42	24.5	24.5	25.5
	ETR16S-16S-12S	16	16	12	30	30	24	24	43	43	42	24.5	24.5	25.5
	ETR16S-16S-20S	16	16	20	30	30	36	27	47	47	48	28.5	28.5	26.5
	ETR20S-20S-10S	20	20	10	36	36	22	27	48	48	46	26.5	26.5	29.5
	ETR20S-20S-12S	20	20	12	36	36	24	27	48	48	46	26.5	26.5	29.5
	ETR20S-20S-16S	20	20	16	36	36	30	27	48	48	47	26.5	26.5	28.5
	ETR20S-20S-25S	20	20	25	36	36	46	36	53	53	54	31.5	31.5	30.0
	ETR25S-25S-16S	25	25	16	46	46	30	36	54	54	52	30.0	30.0	33.5
ETR25S-25S-20S	25	25	20	46	46	36	36	54	54	53	30.0	30.0	31.5	
ETR25S-25S-30S	25	25	30	46	46	50	41	61	61	62	37.0	37.0	35.5	

• Union Cross
EX
 Connects Tubes

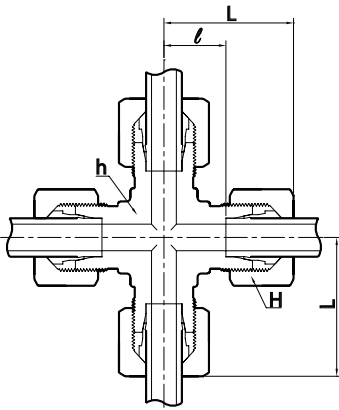

Series	Part No.	Tube O.D.	H	h	L	l
LL PN 100	EX-04LL	4	10	9	21	11.0
	EX-06LL	6	12	9	21	9.5
	EX-08LL	8	14	12	23	11.5
	EX-10LL	10	17	14	24	12.5
	EX-12LL	12	19	14	27	15.0
L PN 315	EX-06L	6	14	12	27	12.0
	EX-08L	8	17	12	29	14.0
	EX-10L	10	19	14	30	15.0
	EX-12L	12	22	17	32	17.0
	EX-15L	15	27	19	36	21.0
PN 160	EX-18L	18	32	24	40	23.5
	EX-22L	22	36	27	44	27.5
	EX-28L	28	41	36	47	30.5
	EX-35L	35	50	41	56	34.5
S PN 630	EX-42L	42	60	50	63	40.0
	EX-06S	6	17	12	31	16.0
	EX-08S	8	19	14	32	17.0
	EX-10S	10	22	17	34	17.5
	EX-12S	12	24	17	38	21.5
PN 400	EX-14S	14	27	19	40	22.0
	EX-16S	16	30	24	43	24.5
	EX-20S	20	36	27	48	26.5
PN 315	EX-25S	25	46	36	54	30.0
	EX-30S	30	50	41	62	35.5
PN 315	EX-38S	38	60	50	72	41.0

DIN 2353 Tube Fittings

• Male Elbow (BSPT/Metric Tapered)

ELM-R/MK

Connects Tube to Female Port

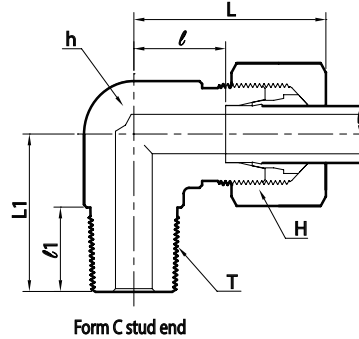

Series	Part No.		Tube O.D.	H	h	L	L1	ℓ	T Metric Taper	ℓ1	T R(PT)	ℓ1
	R	MK										
LL PN 100	ELM04LL-01R	ELM04LL-8MK	4	10	9	21	17	11.0	M 8 x 1 Keg	8	1/8	10
	ELM06LL-01R	ELM06LL-10MK	6	12	9	21	17	9.5	M10 x 1 Keg	8	1/8	10
	ELM08LL-01R	ELM08LL-10MK	8	14	12	23	20	11.5	M10 x 1 Keg	8	1/8	10
	ELM10LL-02R	-	10	17	14	24	23	12.5	-	-	1/4	14
	ELM12LL-02R	-	12	19	17	25	23	13.0	-	-	1/4	14
L PN 315	ELM06L-01R	ELM06L-10MK	6	14	12	27	20	12.0	M10 x 1 Keg	8	1/8	10
	ELM08L-02R	ELM08L-12MK	8	17	12	29	26	14.0	M12 x 1.5Keg	12	1/4	14
	ELM10L-02R	ELM10L-14MK	10	19	14	30	27	15.0	M14 x 1.5Keg	12	1/4	14
	ELM12L-03R	ELM12L-16MK	12	22	17	32	28	17.0	M16 x 1.5Keg	14	3/8	15
	ELM15L-04R	ELM15L-18MK	15	27	19	36	34	21.0	M18 x 1.5Keg	14	1/2	19
S PN 630	ELM18L-04R	ELM18L-22MK	18	32	24	40	36	23.5	M22 x 1.5Keg	17	1/2	19
	ELM06S-02R	ELM06S-12MK	6	17	12	31	26	16.0	M12 x 1.5Keg	12	1/4	14
	ELM08S-02R	ELM08S-14MK	8	19	14	32	27	17.0	M14 x 1.5Keg	12	1/4	14
	ELM10S-03R	ELM10S-16MK	10	22	17	34	28	17.5	M16 x 1.5Keg	12	3/8	15
	ELM12S-03R	ELM12S-18MK	12	24	17	38	28	21.5	M18 x 1.5Keg	12	3/8	15
	ELM14S-04R	ELM14S-20MK	14	27	19	40	32	22.0	M20 x 1.5Keg	14	1/2	19
	ELM16S-04R	ELM16S-22MK	16	30	24	43	32	24.5	M22 x 1.5Keg	17	1/2	19

• Male Connector (NPT Tapered)

EMC-N

Connects Tube to Female Port

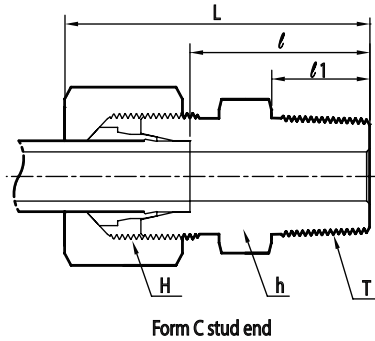

Series	Part No.	Tube O.D.	H	h	L	ℓ	ℓ1	T N(NPT)
LL PN 100	EMC04LL-01N	4	10	11	28	18.5	9.9	1/8-27.0
	EMC06LL-01N	6	12	11	28	16.5	9.9	1/8-27.0
	EMC08LL-01N	8	14	12	30	18.5	9.9	1/8-27.0
L PN 315	EMC06L-01N	6	14	12	32	17.0	9.9	1/8-27.0
	EMC06L-02N	6	14	17	38	23.0	14.2	1/4-18.0
	EMC08L-02N	8	17	17	38	23.0	14.2	1/4-18.0
	EMC10L-02N	10	19	17	39	24.0	14.2	1/4-18.0
	EMC10L-03N	10	19	19	40	25.0	14.2	3/8-18.0
	EMC12L-02N	12	22	19	40	25.0	14.2	1/4-18.0
	EMC12L-03N	12	22	19	40	25.0	14.2	3/8-18.0
	EMC12L-04N	12	22	22	45	30.0	19.1	1/2-14.0
	EMC15L-04N	15	27	24	46	31.0	19.1	1/2-14.0
	EMC18L-04N	18	32	27	48	31.5	19.1	1/2-14.0
PN 160	EMC22L-06N	22	36	32	50	33.5	19.1	3/4-14.0
	EMC28L-08N	28	41	41	56	39.5	23.9	1 - 11.5
	EMC35L-10N	35	50	46	62	40.5	23.9	1 1/4-11.5
	EMC42L-12N	42	60	55	65	42.0	25.4	1 1/2-11.5
S PN 630	EMC06S-02N	6	17	17	43	28.0	14.2	1/4-18.0
	EMC08S-02N	8	19	17	43	28.0	14.2	1/4-18.0
	EMC10S-02N	10	22	19	44	27.5	14.2	1/4-18.0
	EMC10S-03N	10	22	19	44	27.5	14.2	3/8-18.0
	EMC12S-02N	12	24	22	46	29.5	14.2	1/4-18.0
	EMC12S-03N	12	24	22	46	29.5	14.2	3/8-18.0
	EMC12S-04N	12	24	22	51	34.5	19.1	1/2-14.0
PN 400	EMC14S-04N	14	27	24	54	36.0	19.1	1/2-14.0
	EMC16S-04N	16	30	27	54	35.5	19.1	1/2-14.0
	EMC20S-06N	20	36	32	59	37.5	19.1	3/4-14.0
	EMC25S-08N	25	46	41	69	45.0	23.9	1 - 11.5
	EMC30S-10N	30	50	46	73	46.5	23.9	1 1/4-11.5
PN 315	EMC38S-12N	38	60	55	80	49.0	25.4	1 1/2-11.5

DIN 2353 Tube Fittings

Male Connector (BSPT Tapered)

EMC-R

Connects Tube to Female Port

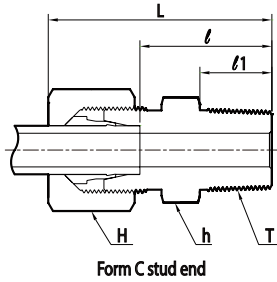

Male Connector (BSPP Parallel)

EMC-GB

Connects Tube to Female Port

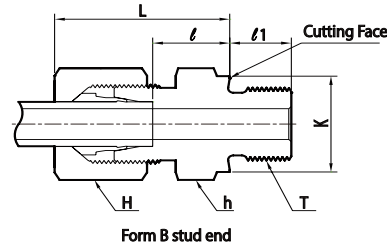

Series	Part No.	Tube O.D.	H	h	K	L	ℓ	ℓ1	T R(PT), G(PF)
LL PN 100	EMC04LL-01R	4	10	11	-	26.0	16.0	8	PT 1/8
	EMC06LL-01R	6	12	11	-	26.0	14.5	8	PT 1/8
	EMC08LL-01R	8	14	12	-	28.0	16.5	8	PT 1/8
	EMC08LL-02R	8	14	14	-	32.0	20.5	12	PT 1/4
	EMC10LL-02R	10	17	14	-	32.0	20.5	12	PT 1/4
	EMC12LL-02R	12	19	17	-	32.0	20.0	12	PT 1/4
	EMC12LL-03R	12	19	17	-	32.0	20.0	12	PT 3/8
L PN 315	EMC06L-01GB	6	14	14	14	23.0	8.5	8	PF 1/8
	EMC06L-01R	6	14	12	-	30.0	15.0	8	PT 1/8
	EMC06L-02GB	6	14	19	18	25.0	10.0	12	PF 1/4
	EMC06L-03GB	6	14	22	22	26.0	11.5	12	PF 3/8
	EMC06L-04GB	6	14	27	26	27.0	12.0	14	PF 1/2
	EMC08L-01GB	8	17	14	14	23.0	8.5	8	PF 1/8
	EMC08L-02GB	8	17	19	18	25.0	10.0	12	PF 1/4
	EMC08L-02R	8	17	17	-	35.0	20.0	12	PT 1/4
	EMC08L-03GB	8	17	22	22	26.0	11.5	12	PF 3/8
	EMC08L-04GB	8	17	27	26	27.0	12.0	14	PF 1/2
	EMC10L-02GB	10	19	19	18	26.0	11.0	12	PF 1/4
	EMC10L-02R	10	19	17	-	36.0	21.0	12	PT 1/4
	EMC10L-03GB	10	19	22	22	27.0	12.5	12	PF 3/8
	EMC10L-04GB	10	19	27	26	28.0	13.0	14	PF 1/2
	EMC12L-02GB	12	22	19	18	27.0	12.0	12	PF 1/4
	EMC12L-02R	12	22	19	-	37.0	22.0	12	PT 1/4
	EMC12L-03GB	12	22	22	22	27.0	12.5	12	PF 3/8
	EMC12L-03R	12	22	19	-	37.0	22.0	12	PT 3/8
	EMC12L-04GB	12	22	27	26	28.0	13.0	14	PF 1/2
	EMC12L-04R	12	22	24	-	39.0	24.0	14	PT 1/2
	EMC12L-06GB	12	22	32	32	29.0	14.0	16	PF 3/4
	EMC15L-03GB	15	27	24	22	29.0	13.5	12	PF 3/8
	EMC15L-03R	15	27	24	-	38.0	23.0	12	PT 3/8
EMC15L-04GB	15	27	27	26	29.0	14.0	14	PF 1/2	
EMC15L-04R	15	27	24	-	40.0	25.0	14	PT 1/2	
EMC15L-06GB	15	27	32	32	30.0	15.0	16.0	PF 3/4	
EMC18L-03GB	18	32	27	22	29.5	14.0	12	PF 3/8	
EMC18L-04GB	18	32	27	26	31.0	14.5	14.0	PF 1/2	
EMC18L-04R	18	32	27	-	41.0	25.5	14.0	PT 1/2	
EMC18L-06GB	18	32	32	32	30.0	14.5	16.0	PF 3/4	

• Male Connector (BSPT Tapered)

EMC-R

Connects Tube to Female Port

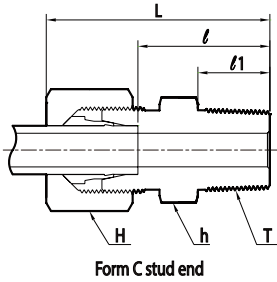

• Male Connector (BSPP Parallel)

EMC-GB

Connects Tube to Female Port

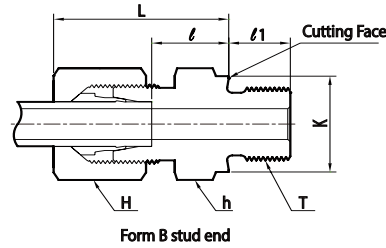

Series	Part No.	Tube O.D.	H	h	K	L	ℓ	ℓ1	T R(PT), G(PF)
L PN 160	EMC22L-04GB	22	36	32	26	33	16.5	14	PF 1/2
	EMC22L-06R	22	36	32	-	46	29.5	16	PT 3/4
	EMC22L-06GB	22	36	32	32	33	16.5	16	PF 3/4
	EMC28L-06GB	28	41	41	32	34	17.5	16	PF 3/4
	EMC28L-08GB	28	41	41	39	34	17.5	18	PF 1
	EMC28L-10GB	35	50	50	49	39	17.5	20	PF 1 1/4
	EMC35L-08GB	35	50	46	39	39	17.5	18	PF1
	EMC42L-12GB	42	60	55	55	42	19.0	22	PF 1 1/2
S PN 630	EMC06S-02GB	6	17	19	18	28	13.0	12	PF 1/4
	EMC06S-04GB	6	17	27	26	33	18.0	14	PF 1/2
	EMC08S-02GB	8	19	19	18	30	15.0	12	PF 1/4
	EMC08S-03GB	8	19	22	22	30	15.5	12	PF 3/8
	EMC10S-02GB	10	22	19	18	31	14.5	12	PF 1/4
	EMC10S-03GB	10	22	22	22	31	15.0	12	PF 3/8
	EMC10S-04GB	10	22	27	26	34	17.5	14	PF 1/2
	EMC12S-02GB	12	24	22	18	33	16.5	12	PF 1/4
	EMC12S-03GB	12	24	22	22	33	17.0	12	PF 3/8
	EMC12S-04GB	12	24	27	26	34	17.5	14	PF 1/2
	EMC14S-03GB	14	27	24	22	36	18.5	12	PF 3/8
	EMC14S-04GB	14	27	27	26	37	19.0	14	PF 1/2
PN 400	EMC16S-03GB	16	30	27	22	36	18.0	12	PF 3/8
	EMC16S-04GB	16	30	27	26	37	18.5	14	PF 1/2
	EMC16S-06GB	16	30	32	32	39	20.5	16	PF 3/4
	EMC20S-04GB	20	36	32	26	42	20.5	14	PF 1/2
	EMC20S-06GB	20	36	32	32	42	20.5	16	PF 3/4
	EMC25S-06GB	25	46	41	32	47	23.0	16	PF 3/4
	EMC25S-08GB	25	46	41	39	47	23.0	18	PF 1
PN 250	EMC30S-08GB	30	50	46	39	50	23.5	18	PF 1
	EMC30S-10GB	30	50	50	49	50	23.5	20	PF 1 1/4
	EMC38S-10GB	38	60	55	49	57	26.0	20	PF 1 1/4
	EMC38S-12GB	38	60	55	55	57	26.0	22	PF 1 1/2

DIN 2353 Tube Fittings

• Male Connector (Metric Tapered)

EMC-MK

Connects Tube to Female Port

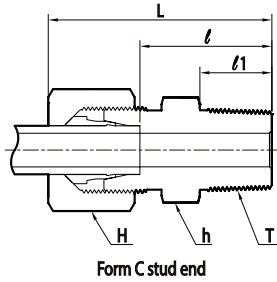

• Male Connector (Metric Parallel)

EMC-MB

Connects Tube to Female Port

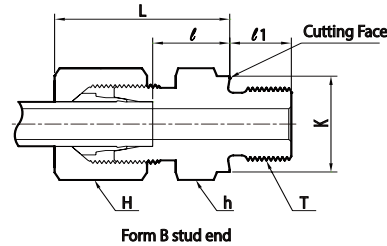

Series	Part No.	Tube O.D.	H	h	K	L	ℓ	ℓ1	T
LL PN 100	EMC04LL-6MK	4	10	9	-	26	16.0	8	M6x1Keg
	EMC04LL-8MK	4	10	10	-	26	16.0	8	M8x1Keg
	EMC06LL-10MK	6	12	11	-	26	14.5	8	M10x1Keg
	EMC08LL-10MK	8	14	12	-	28	16.5	8	M10x1Keg
L PN 315	EMC06L-10MB	6	14	14	14	23	8.5	8	M10x1
	EMC08L-12MB	8	17	17	17	25	10.0	12	M12x1.5
	EMC08L-18MB	8	17	24	23	26	11.5	12	M18x1.5
	EMC10L-14MB	10	19	19	19	26	11.0	12	M14x1.5
	EMC10L-16MB	10	19	22	21	27	12.0	12	M16x1.5
	EMC10L-18MB	10	19	24	23	27	12.5	12	M18x1.5
	EMC10L-22MB	10	19	27	27	29	14.0	14	M22x1.5
	EMC12L-14MB	12	22	19	19	26	11.0	12	M14x1.5
	EMC12L-16MB	12	22	22	21	27	12.5	12	M16x1.5
	EMC12L-18MB	12	22	24	23	27	12.5	12	M18x1.5
	EMC12L-22MB	12	22	27	27	29	14.0	14	M22x1.5
	EMC15L-16MB	15	27	24	21	28	13.0	12	M16x1.5
	EMC15L-18MB	15	27	24	23	29	13.5	12	M18x1.5
	EMC15L-22MB	15	27	27	27	30	15.0	14	M22x1.5
	EMC18L-18MB	18	32	27	23	30	14.0	12	M18x1.5
	EMC18L-22MB	18	32	27	27	31	14.5	14	M22x1.5
PN160	EMC22L-22MB	22	36	27	27	33	16.5	14	M22x1.5
	EMC22L-26MB	22	36	32	31	33	16.5	16	M26x1.5
	EMC28L-33MB	28	41	32	39	34	17.5	18	M33x2
	EMC35L-42MB	35	50	41	49	39	17.5	20	M42x2
	EMC42L-48MB	42	60	50	55	42	19.0	22	M48x2
S PN 630	EMC06S-12MB	6	17	55	17	28	13.0	12	M12x1.5
	EMC08S-14MB	8	19	17	19	30	15.0	12	M14x1.5
	EMC10S-16MB	10	22	19	21	31	15.0	12	M16x1.5
	EMC12S-18MB	12	24	22	23	33	17.0	12	M18x1.5
	EMC12S-22MB	12	24	24	27	34	17.5	14	M22x1.5
	EMC14S-20MB	14	27	27	25	37	19.0	14	M20x1.5
PN400	EMC16S-18MB	16	30	27	23	36	18.0	12	M18x1.5
	EMC16S-22MB	16	30	27	27	37	18.5	14	M22x1.5
	EMC20S-27MB	20	36	32	32	42	20.5	16	M27x2
	EMC25S-33MB	25	46	41	39	47	23.0	18	M33x2
PN250	EMC30S-42MB	30	50	50	49	50	23.5	20	M42x2
	EMC38S-48MB	38	60	55	55	57	26.0	22	M48x2

• Male Connector (BSPP Parallel) with ED-Ring

EMC-GE

Connect Tube to Female Port

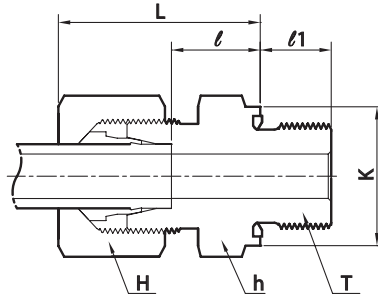

Form E stud end

Series	Part No.	Tube O.D.	H	h	K	L	ℓ	ℓ1	T G(PF)
L PN 315	EMC06L-01GE	6	14	14	14	23	8.5	8	1/8
	EMC06L-02GE	6	14	19	19	25	10.0	12	1/4
	EMC08L-01GE	8	17	14	14	24	9.5	8	1/8
	EMC08L-02GE	8	17	19	19	25	10.0	12	1/4
	EMC08L-03GE	8	17	22	22	26	11.5	12	3/8
	EMC10L-02GE	10	19	19	19	26	11.0	12	1/4
	EMC10L-03GE	10	19	22	22	27	12.5	14	3/8
	EMC10L-04GE	10	19	27	27	28	13.0	12	1/2
	EMC12L-02GE	12	22	19	19	27	12.0	12	1/4
	EMC12L-03GE	12	22	22	22	27	12.5	14	3/8
	EMC12L-04GE	12	22	27	27	28	13.0	12	1/2
	EMC15L-03GE	15	27	24	22	29	13.5	14	3/8
	EMC15L-04GE	15	27	27	27	29	14.0	14	1/2
	EMC18L-04GE	18	32	27	27	31	14.5	16	1/2
EMC18L-06GE	18	32	32	32	31	14.5	16	3/4	
PN 160	EMC22L-06GE	22	36	32	32	33	16.5	18	3/4
	EMC28L-08GE	28	41	41	40	34	17.5	20	1
	EMC35L-10GE	35	50	50	50	39	17.5	22	1 1/4
	EMC42L-12GE	42	60	55	55	42	19.0	12	1 1/2
S PN 630	EMC06S-02GE	6	17	19	19	28	13.0	12	1/4
	EMC08S-02GE	8	19	19	19	30	15.0	12	1/4
	EMC08S-03GE	8	19	22	22	30	15.5	12	3/8
	EMC10S-02GE	10	22	19	19	31	14.5	12	1/4
	EMC10S-03GE	10	22	27	22	31	15.0	12	3/8
	EMC10S-04GE	10	22	22	27	34	17.5	14	1/2
	EMC12S-02GE	12	24	22	19	33	16.5	12	1/4
	EMC12S-03GE	12	24	22	22	33	17.0	12	3/8
	EMC12S-04GE	12	24	27	32	34	17.5	14	1/2
EMC14S-04GE	14	27	27	27	37	19.0	14	1/2	
PN 400	EMC16S-03GE	16	30	27	22	36	18.0	12	3/8
	EMC16S-04GE	16	30	27	27	37	18.5	14	1/2
	EMC16S-06GE	16	30	32	27	39	20.5	16	3/4
	EMC20S-06GE	20	36	32	32	42	20.5	16	3/4
	EMC25S-04GE	25	46	41	27	47	23.0	14	1/2
	EMC25S-06GE	25	46	41	32	47	23.0	16	3/4
	EMC25S-08GE	25	46	41	40	47	23.0	18	1
EMC30S-10GE	30	50	50	50	50	23.5	20	1 1/4	
PN 315	EMC38S-12GE	38	60	55	55	57	26.0	22	1 1/2

● Fittings are supplied with the standard seal material of NBR ED-Ring.

DIN 2353 Tube Fittings

Male Connector (Metric Parallel) with ED-Ring

EMC-ME

Connects Tube to Female Port

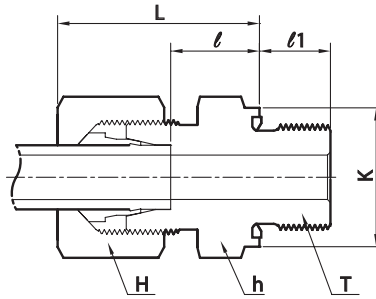

Form E stud end

Series	Part No.	Tube O.D.	H	h	K	L	ℓ	ℓ1	T M(METRIC)
L PN 315	EMC06L-10ME	6	14	14	14	23	8.5	8	M10x1
	EMC08L-12ME	8	17	17	17	25	10.0	12	M12x1.5
	EMC10L-14ME	10	19	19	19	26	11.0	12	M14x1.5
	EMC12L-16ME	12	22	22	22	27	12.5	12	M16x1.5
	EMC12L-18ME	12	22	24	24	27	12.5	12	M18x1.5
	EMC12L-22ME	12	22	27	27	29	14.0	14	M22x1.5
	EMC15L-18ME	15	27	24	24	29	13.5	12	M18x1.5
	EMC15L-22ME	15	27	27	27	30	15.0	14	M22x1.5
PN 160	EMC18L-22ME	18	32	27	27	31	14.5	14	M22x1.5
	EMC22L-26ME	22	36	32	32	33	16.5	16	M26x1.5
	EMC28L-33ME	28	41	41	40	34	17.5	18	M33x2
	EMC35L-42ME	35	50	50	50	39	17.5	20	M42x2
S PN 630	EMC42L-48ME	42	60	55	55	42	19.0	22	M48x2
	EMC06S-12ME	6	17	17	17	28	13.0	12	M12x1.5
	EMC08S-14ME	8	19	19	19	30	15.0	12	M14x1.5
	EMC10S-16ME	10	22	22	22	31	15.0	12	M16x1.5
	EMC12S-18ME	12	24	24	24	33	17.0	12	M18x1.5
PN 400	EMC14S-20ME	14	27	27	26	37	19.0	14	M20x1.5
	EMC16S-22ME	16	30	27	27	37	18.5	14	M22x1.5
	EMC20S-27ME	20	36	32	32	42	20.5	16	M27x2
	EMC25S-33ME	25	46	41	40	47	23.0	18	M33x2
PN 315	EMC30S-42ME	30	50	50	50	50	23.5	20	M42x2
	EMC38S-48ME	38	60	55	55	57	26.0	22	M48x2

● Fittings are supplied with the standard seal material of NBR ED-Ring.

Male Connector (Unified/Metric Parallel) with O-Ring

EMC-UF/MF

Connects Tube to Female Port

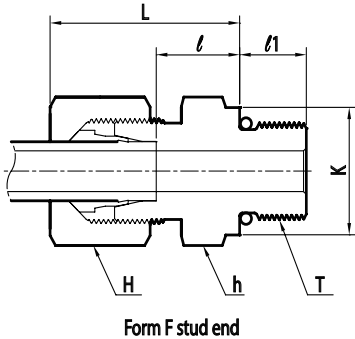

Unified - UF

Series	Part No.	Tube O.D.	H	h	K	L	ℓ1	ℓ	T U (Unified)
L PN 315	EMC08L-4UF	8	17	17	14.4	25	9.0	10.0	7/16-20 UNF-2A
	EMC10L-4UF	10	19	17	14.4	26	10.0	11.0	7/16-20 UNF-2A
	EMC12L-6UF	12	22	19	17.6	26	10.0	11.0	9/16-18 UNF-2A
	EMC12L-8UF	12	22	24	22.3	28	11.0	13.0	3/4-16 UNF-2A
	EMC12L-10UF	12	22	27	25.5	29	12.7	14.3	7/8-14 UNF-2A
	EMC15L-8UF	15	27	24	22.3	29	11.0	14.0	3/4-16 UNF-2A
	EMC15L-10UF	15	27	27	25.5	30	12.7	15.3	7/8-14 UNF-2A
	EMC18L-8UF	18	32	27	22.3	31	11.0	14.5	3/4-16 UNF-2A
	EMC18L-10UF	18	32	27	25.5	31	12.7	14.8	7/8-14 UNF-2A
PN 160	EMC22L-10UF	22	36	32	25.5	33	12.7	16.8	7/8-14 UNF-2A
	EMC22L-12UF	22	36	32	31.9	33	15.0	16.5	1 1/16-20 UN-2A
	EMC22L-16UF	22	36	41	38.2	34	15.0	17.5	1 5/16-12 UN-2A
	EMC28L-12UF	28	41	41	31.9	34	15.0	17.5	1 1/16-12 UN-2A
	EMC28L-16UF	28	41	41	38.2	34	15.0	17.5	1 5/16-12 UN-2A
	EMC35L-16UF	35	50	46	38.2	39	15.0	17.5	1 5/16-12 UN-2A
	EMC35L-20UF	35	50	50	47.7	39	15.0	17.5	1 5/8-12 UN-2A
S PN 630	EMC42L-20UF	42	60	55	47.7	42	15.0	19.0	1 5/8-12 UN-2A
	EMC08S-4UF	8	19	17	16.0	30	9.0	15.0	7/16-20 UNF-2A
	EMC10S-6UF	10	22	19	17.6	31	10.0	14.5	9/16-18 UNF-2A
	EMC12S-6UF	12	24	22	17.6	31	10.0	14.5	9/16-18 UNF-2A
PN 400	EMC12S-8UF	12	24	24	22.3	34	11.0	17.5	3/4-16 UNF-2A
	EMC16S-8UF	16	30	24	22.3	34	11.0	15.5	3/4-16 UNF-2A
	EMC16S-10UF	16	30	27	25.5	37	12.7	18.8	7/8-14 UNF-2A
	EMC20S-8UF	20	36	32	22.3	42	11.0	20.5	3/4-16 UNF-2A
	EMC20S-10UF	20	36	32	25.5	42	12.7	20.8	7/8-14 UNF-2A
	EMC20S-12UF	20	36	32	31.9	42	15.0	20.5	1 1/16-20 UN-2A
	EMC25S-12UF	25	46	36	31.9	47	15.0	23.0	1 1/16-20 UN-2A
	EMC25S-16UF	25	46	41	38.2	47	15.0	23.0	1 5/16-12 UN-2A
	EMC30S-16UF	30	50	46	38.2	50	15.0	23.5	1 5/16-12 UN-2A
PN 315	EMC38S-20UF	38	60	55	47.7	57	15.0	26.0	1 5/8-12 UN-2A

Metric Parallel - MF

Series	Part No.	Tube O.D.	H	h	K	L	ℓ1	ℓ	T M (Metric)
L PN 315	EMC06L-10MF	6	14	14	-	23	10.0	8.5	M10X1
	EMC08L-12MF	8	17	17	-	25	11.5	10.0	M12x1.5
	EMC10L-14MF	10	19	19	-	26	11.5	11.0	M14x1.5
	EMC12L-16MF	12	22	22	-	27	13.0	12.0	M16x1.5
	EMC15L-18MF	15	27	24	-	29	14.5	13.5	M18x1.5
	EMC18L-22MF	18	32	27	-	30	15.5	14.0	M22x1.5
PN 160	EMC22L-26MF	22	36	32	-	32	16.0	16.0	M26x1.5
	EMC28L-33MF	28	41	41	38	34	19.0	17.5	M33x2
	EMC35L-42MF	35	50	50	48	39	19.5	17.5	M42x2
S PN 630	EMC06S-12MF	6	17	17	-	27	11.5	12.0	M12x1.5
	EMC08S-14MF	8	19	19	-	27	11.5	12.0	M14x1.5
	EMC10S-16MF	10	22	22	-	29	13.0	12.5	M16x1.5
	EMC12S-18MF	12	24	24	-	29	14.5	13.0	M18x1.5
PN 400	EMC16S-22MF	18	30	27	-	33	15.5	15.0	M22x1.5
	EMC20S-27MF	20	36	32	-	37	19.0	15.0	M27x2
	EMC25S-33MF	25	46	41	38	41	19.0	17.0	M33x2
	EMC30S-42MF	30	50	50	48	45	19.5	18.5	M42x2

● Fittings are supplied with the standard seal material of NBR O-Ring.

Female Connector (BSPP/Metric Parallel)

EFC-G/M

Connects Tube to Male Port

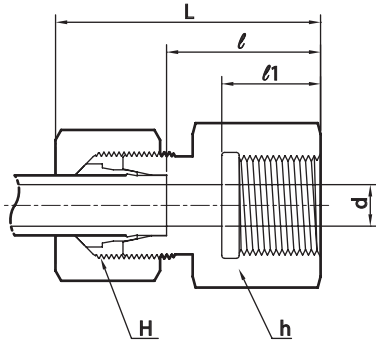

BSPP Parallel - G

Series	Part No.	Tube O.D.	d	H	h	L	ℓ	ℓ1	T G(PF)
L PN 315	EFC06L-01G	6	4	14	14	34	19.0	12.0	1/8
	EFC08L-02G	8	6	17	19	39	24.0	17.0	1/4
	EFC08L-03G	8	6	17	24	40	25.0	17.0	3/8
	EFC08L-04G	8	6	17	27	44	29.0	20.0	1/2
	EFC10L-02G	10	8	19	19	40	25.0	17.0	1/4
	EFC10L-03G	10	8	19	24	41	26.0	17.0	3/8
	EFC10L-04G	10	8	19	27	45	30.0	20.0	1/2
	EFC12L-03G	12	10	22	24	41	26.0	17.0	3/8
	EFC12L-04G	12	10	22	27	45	30.0	20.0	1/2
	EFC15L-04G	15	12	27	27	46	31.0	20.0	1/2
PN 160	EFC18L-04G	18	15	32	27	47	30.5	20.0	1/2
	EFC22L-06G	22	19	36	36	52	35.5	22.0	3/4
	EFC28L-08G	28	24	41	41	55	38.0	24.5	1
	EFC35L-10G	35	30	50	55	63	41.0	26.5	1 1/4
S PN 630	EFC42L-12G	42	36	60	60	65	42.5	28.5	1 1/2
	EFC06S-02G	6	4	17	19	41	26.0	17.0	1/4
	EFC08S-02G	8	5	19	19	41	26.0	17.0	1/4
	EFC10S-03G	10	7	22	24	43	26.5	17.0	3/8
PN 400	EFC12S-03G	12	8	24	24	43	26.5	17.0	3/8
	EFC14S-04G	14	10	27	30	50	32.0	20.0	1/2
	EFC 6S-04G	16	12	30	30	50	31.5	20.0	1/2
	EFC20S-06G	20	16	36	36	56	34.5	22.0	3/4
PN 315	EFC25S-08G	25	20	46	41	62	37.5	24.5	1
	EFC30S-10G	30	25	50	55	69	42.0	26.5	1 1/4
PN 315	EFC38S-12G	38	32	60	60	74	43.5	28.5	1 1/2

Metric Parallel - M

Series	Part No.	Tube O.D.	d	H	h	L	ℓ	ℓ1	T M(Metric)
L PN 315	EFC06L-10M	6	4	14	14	34	19.5	12.5	M10 x 1
	EFC08L-12M	8	6	17	17	39	24.0	17.0	M12 x 1.5
	EFC10L-14M	10	8	19	19	40	25.0	17.0	M14 x 1.5
	EFC12L-16M	12	10	22	22	41	26.0	17.0	M16 x 1.5
	EFC15L-18M	15	12	27	24	43	28.0	17.0	M18 x 1.5
	EFC18L-22M	18	15	32	30	46	29.5	19.0	M22 x 1.5
PN 160	EFC22L-26M	22	19	36	32	51	34.5	21.0	M26 x 1.5
	EFC28L-33M	28	24	41	41	54	37.5	24.0	M33 x 2
	EFC35L-42M	35	30	50	55	62	40.5	26.0	M42 x 2
	EFC42L-48M	42	36	60	60	65	42.0	28.0	M48 x 2
S PN 630	EFC06S-12M	6	4	17	17	41	26.0	17.0	M12 x 1.5
	EFC08S-14M	8	5	19	19	41	26.0	17.0	M14 x 1.5
	EFC10S-16M	10	7	22	22	43	26.5	17.0	M16 x 1.5
	EFC12S-18M	12	8	24	24	44	27.5	17.0	M18 x 1.5
	EFC14S-20M	14	10	27	27	49	31.0	19.0	M20 x 1.5
PN 400	EFC16S-22M	16	12	30	30	49	30.5	19.0	M22 x 1.5
	EFC20S-27M	20	16	36	36	56	34.5	22.0	M27 x 2
	EFC25S-33M	25	20	46	41	61	37.0	24.0	M33 x 2
	EFC30S-42M	30	25	50	55	68	41.5	26.0	M42 x 2
PN 315	EFC38S-48M	38	32	60	60	74	43.0	28.0	M48 x 2

Female Connector (BSPP Parallel) with EKI Ring

EFC-GG

Connects Tube to Pressure Gauge

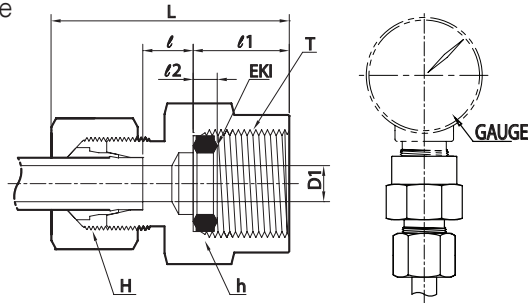

“GG” stands for BSPP port for Pressure Gauge

Series	Part No.	Tube O.D.	D1	H	h	L	l	l1	l2	T G(PF)
L PN 315	EFC06L-02GG	6	2.5	14	19	37	7.5	14.5	4.5	1/4
	EFC08L-02GG	8	5.5	17	19	37	7.5	14.5	4.5	1/4
	EFC10L-02GG	10	5.5	19	19	38	8.5	14.5	4.5	1/4
	EFC12L-02GG	12	5.5	22	19	38	8.5	14.5	4.5	1/4
S PN 630	EFC06S-04GG	6	3.5	17	27	46	11.0	20.0	5.0	1/2
	EFC08S-04GG	8	3.5	19	27	46	11.0	20.0	5.0	1/2
	EFC10S-04GG	10	7.0	22	27	47	10.5	20.0	5.0	1/2
	EFC12S-04GG	12	7.0	24	27	47	10.5	20.0	5.0	1/2

Standpipe Female Connector (BSPP Parallel) with EKI-Ring

EGA-GG

Connects Tube Port to Pressure Gauge

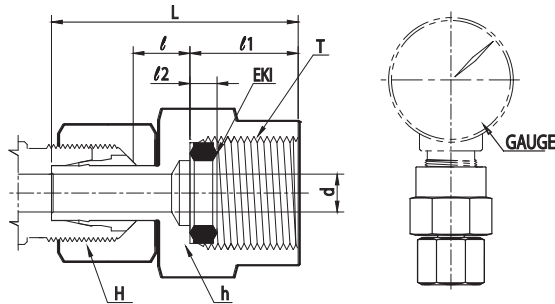

Series	Part No.	Tube O.D.	D1	H	h	L	l1	l2	T G(PF)
L PN 315	EGA06L-02GG	6	3.5	14	19	38.0	14.5	4.5	1/4
	EGA08L-02GG	8	5.5	17	19	38.0	14.5	4.5	1/4
	EGA10L-02GG	10	7.5	19	19	39.5	14.5	4.5	1/4
	EGA12L-02GG	12	9	22	19	40.5	14.5	4.5	1/4
S PN 630	EGA06S-04GG	6	3.5	17	27	45.0	20.0	5.0	1/2
	EGA08S-04GG	8	4.5	19	27	45.0	20.0	5.0	1/2
	EGA10S-04GG	10	6.5	22	27	47.0	20.0	5.0	1/2
	EGA12S-04GG	12	7.5	24	27	47.5	20.0	5.0	1/2

Swivel Female Connector (BSPF Parallel) with EKI-Ring

EGE-GG

Connects Tube Port to Pressure Gauge

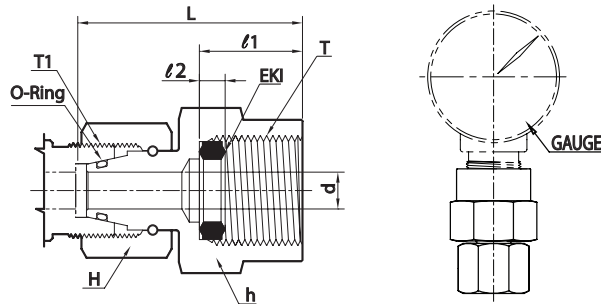

Series	Part No.	Tube O.D.	D1	H	h	L	l1	l2	T G(PF)
L PN 315	EGE06L-02GG	6	2.5	14	19	35.5	14.5	4.5	1/4
	EGE08L-02GG	8	4.0	17	19	35.5	14.5	4.5	1/4
	EGE10L-02GG	10	5.5	19	19	36.0	14.5	4.5	1/4
	EGE12L-02GG	12	5.5	22	19	36.0	14.5	4.5	1/4
S PN 630	EGE06S-02GG	6	2.5	17	19	35.5	14.5	4.5	1/4
	EGE08S-02GG	8	4.0	19	19	35.5	14.5	4.5	1/4
	EGE10S-02GG	10	6.0	22	19	36.0	14.5	4.5	1/4
	EGE12S-02GG	12	7.0	24	19	39.0	14.5	4.5	1/4
	EGE06S-04GG	6	2.5	17	27	42.5	20.0	5.0	1/2
	EGE08S-04GG	8	4.0	19	27	43.0	20.0	5.0	1/2
	EGE10S-04GG	10	6.0	22	27	43.5	20.0	5.0	1/2
EGE12S-04GG	12	7.0	24	27	45.0	20.0	5.0	1/2	

Sealing-Ring

EKI

for EFC/EGA/EGE-GG

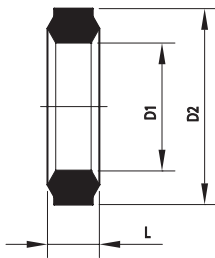

Part No.	Internal Thread	D1	D2	L1
EKI-02G	PF 1/4	6	11.3	4.5
EKI-04G	PF 1/2	12	18.5	5.0

Weld Connector

EAS

Connects Tube to Weld End

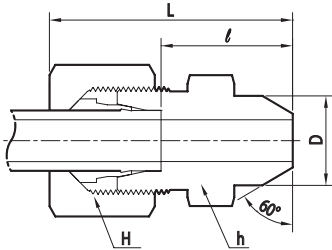

Series	Part No.	Tube O.D.	D	H	h	L	ℓ	PN bar	
								C	SS
L	EAS-06L	6	10	14	12	29	14.0	315	315
	EAS-08L	8	12	17	14	31	16.0	315	315
	EAS-10L	10	14	19	17	33	18.0	315	315
	EAS-12L	12	16	22	19	33	18.0	315	315
	EAS-15L	15	19	27	22	37	22.0	315	315
	EAS-18L	18	22	32	27	40	23.5	315	315
	EAS-22L	22	27	36	32	45	28.5	160	160
	EAS-28L	28	32	41	41	47	30.5	160	160
	EAS-35L	35	40	50	46	54	32.5	160	160
	EAS-42L	42	46	60	55	58	35.0	160	160
S	EAS-06S	6	11	17	14	34	19.0	630	630
	EAS-08S	8	13	19	17	36	21.0	630	630
	EAS-10S	10	15	22	19	39	22.5	630	630
	EAS-12S	12	17	24	22	41	24.5	630	630
	EAS-14S	14	19	27	24	45	27.0	630	630
	EAS-16S	16	21	30	27	45	26.5	400	400
	EAS-20S	20	26	36	32	51	29.5	400	400
	EAS-25S	25	31	46	41	56	32.0	400	400
	EAS-30S	30	36	50	46	62	35.5	400	400
	EAS-38S	38	44	60	55	69	38.0	315	315

Weld Nipple with O-Ring

EAK

Connects Weld End to Tube Port

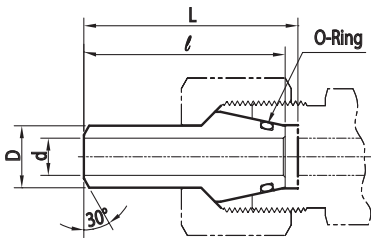

Series	Part No.	Tube O.D.	d	L	ℓ	PN bar		
		D				C	SS	
L/S	EAK10-1.0	10	8	35.5	33.0	249	242	
	EAK10-1.5	10	7	35.5	33.0	358	349	
	EAK10-2.0	10	6	35.5	33.0	460	447	
	EAK12-1.5	12	9	35.5	33.0	305	297	
	EAK12-2.0	12	8	35.5	33.0	393	383	
	EAK12-2.5	12	7	35.5	33.0	476	463	
	S	EAK16-1.5	16	13	42.5	39.0	234	228
		EAK16-2.0	16	12	42.5	39.0	305	297
		EAK16-2.5	16	11	42.5	39.0	372	362
		EAK16-3.0	16	10	42.5	39.0	400	400
EAK20-2.0		20	16	47.5	43.5	249	242	
EAK20-2.5		20	15	47.5	43.5	305	297	
EAK20-3.0		20	14	47.5	43.5	358	349	
EAK20-4.0		20	12	47.5	43.5	400	400	
EAK25-3.0		25	19	55.0	49.5	294	286	
EAK25-4.0		25	17	55.0	49.5	379	369	
EAK25-5.0		25	15	55.0	49.5	400	400	
EAK30-3.0		30	24	58.5	51.5	249	242	
EAK30-4.0		30	22	58.5	51.5	323	314	
EAK30-5.0		30	20	58.5	51.5	393	383	
EAK30-6.0		30	18	58.5	51.5	400	400	
EAK38-4.0		38	30	66.0	56.5	261	254	
EAK38-5.0		38	28	66.0	56.5	315	315	
EAK38-6.0		38	26	66.0	56.5	315	315	
EAK38-7.0	38	24	66.0	56.5	315	315		

Weld Connector with EAK

EASK

Connects Weld Ends

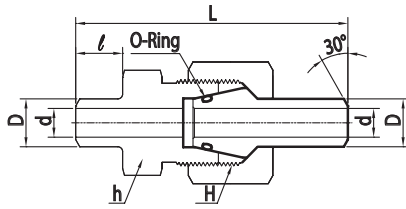

Series	Part No.	Tube O.D.		d	H	h	L	ℓ	PN bar	
		D							C	SS
S	EASK10-1.0	10		8	22	19	58.0	10.0	249	242
	EASK10-1.5	10		7	22	19	58.0	10.0	358	349
	EASK10-2.0	10		6	22	19	58.0	10.0	460	447
	EASK12-1.5	12		9	24	22	65.0	15.0	305	297
	EASK12-2.0	12		8	24	22	65.0	15.0	393	383
	EASK12-2.5	12		7	24	22	65.0	15.0	476	463
	EASK16-1.5	16		13	30	27	74.5	16.5	234	228
	EASK16-2.0	16		12	30	27	74.5	16.5	305	297
	EASK16-2.5	16		11	30	27	74.5	16.5	372	362
	EASK16-3.0	16		10	30	27	74.5	16.5	400	400
	EASK20-2.0	20		16	36	32	84.0	19.0	249	242
	EASK20-2.5	20		15	36	32	84.0	19.0	305	297
	EASK20-3.0	20		14	36	32	84.0	19.0	358	349
	EASK20-4.0	20		12	36	32	84.0	19.0	400	400
	EASK25-3.0	25		19	46	41	94.5	19.5	294	286
	EASK25-4.0	25		17	46	41	94.5	19.5	379	369
	EASK25-5.0	25		15	46	41	94.5	19.5	400	400
	EASK30-3.0	30		24	50	46	102.0	23.0	249	242
	EASK30-4.0	30		22	50	46	102.0	23.0	323	314
	EASK30-5.0	30		20	50	46	102.0	23.0	393	383
EASK30-6.0	30		18	50	46	102.0	23.0	400	400	
EASK38-4.0	38		30	60	55	111.0	23.0	261	254	
EASK38-5.0	38		28	60	55	111.0	23.0	315	311	
EASK38-6.0	38		26	60	55	111.0	23.0	315	315	
EASK38-7.0	38		24	60	55	111.0	23.0	315	315	

Reducing Weld Nipple with O-Ring

EAKR

Connects Tube Port to Weld End

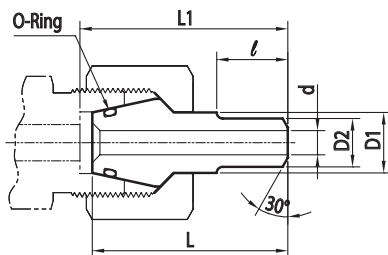

Series	Part No.	Tube O.D.		d1	L2	L1	L	ℓ	PN bar	
		D1	D2						C	SS
L/S	EAKR1006-1.5	10	6	3	5	37.5	35.0	12	528	539
	EAKR1008-2.0	10	8	4	-	37.5	35.0	12	528	539
	EAKR1208-2.0	12	8	4	6	37.5	35.0	14	528	539
	EAKR1210-1.5	12	10	7	-	37.5	35.0	14	358	349
S	EAKR1612-2.5	16	12	7	-	46.5	43.0	15	400	400
	EAKR2012-2.5	20	12	7	-	51.5	47.5	15	400	400
	EAKR2016-3.0	20	16	10	-	53.5	49.5	17	400	400
	EAKR2516-3.0	25	16	10	-	56.5	51.0	17	400	400
	EAKR2520-4.0	25	20	12	-	59.5	54.0	20	400	400
	EAKR3016-2.0	30	16	12	-	67.0	60.0	17	305	297
	EAKR3020-2.5	30	20	15	-	70.0	63.0	20	305	297
	EAKR3025-3.0	30	25	19	-	70.0	63.0	20	294	286
	EAKR3816-2.0	38	16	12	-	79.0	69.5	17	305	297
	EAKR3820-2.5	38	20	15	-	82.0	72.5	20	305	297
	EAKR3825-3.0	38	25	19	-	82.0	72.5	20	294	286
	EAKR3830-4.0	38	30	22	-	82.0	72.5	20	315	315

Ordering Information
Fittings completed with EAK Weld Nipple.

EAK Nipple designed to ISO8434-4 helps any fitting turns out to be weld fitting by having the EAK on tube port.

To order fitting assembled with EAK Nipple, insert “**K**” in the fitting part number.

Examples : EUK-22L-SS, EMCK18L-04R-SS

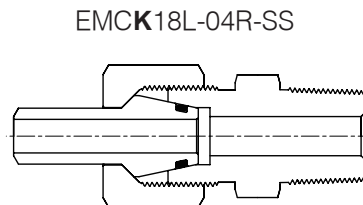
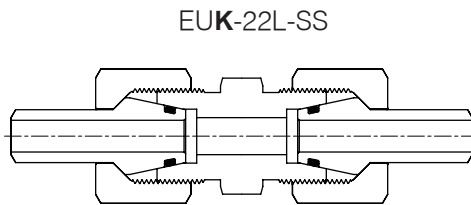

Since the EAK Nipple replaces the cutting ring in the fitting, the fitting assembled with EAK nipple is supplied with no cutting ring.

Welding Information
EAK and EAKR Weld Nipple

1. To protect from weld heat, remove the O-ring from weld nipple.
2. Place the Nut onto weld nipple before the weld nipple gets welded with tube.
3. Complete welding keeping the tube and weld nipple in line, and descale the weld.
4. Clean the Cone & O-Ring groove on the nipple before O-Ring is placed, and lubricate the O-Ring and thread on both of nut & body with oil.
5. Hand-tighten the Nut on the welded nipple onto the fitting body.
 Refer to page on 64 for final assembly.

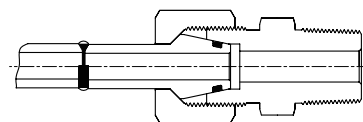
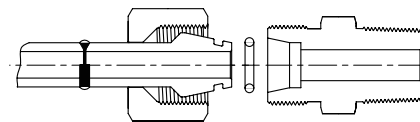
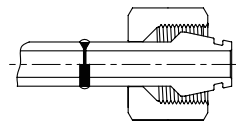
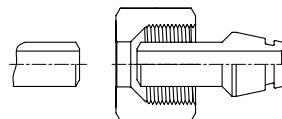
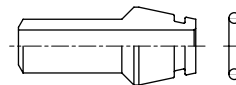

Adjustable Standpipe Elbow

ELA

Connects Tube to Tube Port

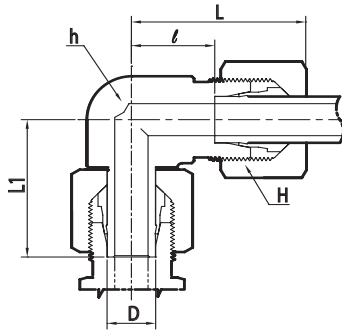

Series	Part No.	Tube O.D.	D	H	h	L	L1	ℓ	T
L PN 315	ELA-06L	6	6	14	12	27	26.0	12.0	M12 x 1.5
	ELA-08L	8	8	17	12	29	27.5	14.0	M14 x 1.5
	ELA-10L	10	10	19	14	30	29.0	15.0	M16 x 1.5
	ELA-12L	12	12	22	17	32	29.5	17.0	M18 x 1.5
	ELA-15L	15	15	27	19	36	32.5	21.0	M22 x 1.5
PN 160	ELA-18L	18	18	32	24	40	35.5	23.5	M26 x 1.5
	ELA-22L	22	22	36	27	44	38.5	27.5	M30 x 2
	ELA-28L	28	28	41	36	47	41.5	30.5	M36 x 2
	ELA-35L	35	35	50	41	56	51.0	34.5	M45 x 2
S PN 630	ELA-42L	42	42	60	50	63	56.0	40.0	M52 x 2
	ELA-06S	6	6	17	12	31	27.0	16.0	M14 x 1.5
	ELA-08S	8	8	19	14	32	27.5	17.0	M16 x 1.5
	ELA-10S	10	10	22	17	34	30.0	17.5	M18 x 1.5
	ELA-12S	12	12	24	17	38	31.0	21.5	M20 x 1.5
PN 400	ELA-14S	14	14	27	19	40	35.0	22.0	M22 x 1.5
	ELA-16S	16	16	30	24	43	36.5	24.5	M24 x 1.5
	ELA-20S	20	20	36	27	48	44.5	26.5	M30 x 2
	ELA-25S	25	25	46	36	54	50.0	30.0	M36 x 2
PN 315	ELA-30S	30	30	50	41	62	55.0	35.5	M42 x 2
	ELA-38S	38	38	60	50	72	63.0	41.0	M52 x 2

Adjustable Standpipe Branch Tee

EBTA

Connects Tubes to Tube Port

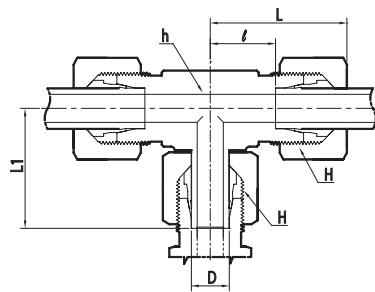

Series	Part No.	Tube O.D.	D	H	h	L	L1	ℓ	T
L PN 315	EBTA-06L	6	6	14	12	27	26.0	12.0	M12 x 1.5
	EBTA-08L	8	8	17	12	29	27.5	14.0	M14 x 1.5
	EBTA-10L	10	10	19	14	30	29.0	15.0	M16 x 1.5
	EBTA-12L	12	12	22	17	32	29.5	17.0	M18 x 1.5
	EBTA-15L	15	15	27	19	36	32.5	21.0	M22 x 1.5
PN 160	EBTA-18L	18	18	32	24	40	35.5	23.5	M26 x 1.5
	EBTA-22L	22	22	36	27	44	38.5	27.5	M30 x 2
	EBTA-28L	28	28	41	36	47	41.5	30.5	M36 x 2
	EBTA-35L	35	35	50	41	56	51.0	34.5	M45 x 2
S PN 630	EBTA-42L	42	42	60	50	63	56.0	40.0	M52 x 2
	EBTA-06S	6	6	17	12	31	27.0	16.0	M14 x 1.5
	EBTA-08S	8	8	19	14	32	27.5	17.0	M16 x 1.5
	EBTA-10S	10	10	22	17	34	30.0	17.5	M18 x 1.5
	EBTA-12S	12	12	24	17	38	31.0	21.5	M20 x 1.5
PN 400	EBTA-14S	14	14	27	19	40	35.0	22.0	M22 x 1.5
	EBTA-16S	16	16	30	24	43	36.5	24.5	M24 x 1.5
	EBTA-20S	20	20	36	27	48	44.5	26.5	M30 x 2
	EBTA-25S	25	25	46	36	54	50.0	30.0	M36 x 2
PN 315	EBTA-30S	30	30	50	41	62	55.0	35.5	M42 x 2
	EBTA-38S	38	38	60	50	72	63.0	41.0	M52 x 2

Adjustable Standpipe Run Tee

ERTA

Connects Tubes to Tube Port

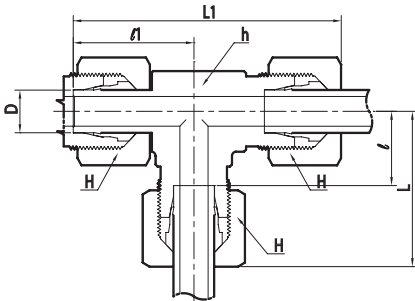

Series	Part No.	Tube O.D.	D	h	H	L	L1	ℓ	ℓ1	T
L PN 315	ERTA-06L	6	6	12	14	27	53	12.0	26.0	M12 x 1.5
	ERTA-08L	8	8	12	17	29	56	14.0	27.5	M14 x 1.5
	ERTA-10L	10	10	14	19	30	59	15.0	29.0	M16 x 1.5
	ERTA-12L	12	12	17	22	32	62	17.0	29.5	M18 x 1.5
	ERTA-15L	15	15	19	27	36	69	21.0	32.5	M22 x 1.5
PN 160	ERTA-18L	18	18	24	32	40	75	23.5	35.5	M26 x 1.5
	ERTA-22L	22	22	27	36	44	83	27.5	38.5	M30 x 2
	ERTA-28L	28	28	36	41	47	91	30.5	41.5	M36 x 2
	ERTA-35L	35	35	41	50	56	111	34.5	51.0	M45 x 2
S PN 630	ERTA-42L	42	42	50	60	63	123	40.0	56.0	M52 x 2
	ERTA-06S	6	6	12	17	31	58	16.0	27.0	M14 x 1.5
	ERTA-08S	8	8	14	19	32	61	17.0	27.5	M16 x 1.5
	ERTA-10S	10	10	17	22	34	66	17.5	30.0	M18 x 1.5
	ERTA-12S	12	12	17	24	38	71	21.5	31.0	M20 x 1.5
PN 400	ERTA-14S	14	14	19	27	40	75	22.0	35.0	M22 x 1.5
	ERTA-16S	16	16	24	30	43	79	24.5	36.5	M24 x 1.5
	ERTA-20S	20	20	27	36	48	93	26.5	44.5	M30 x 2
	ERTA-25S	25	25	36	46	54	105	30.0	50.0	M36 x 2
PN 315	ERTA-30S	30	30	41	50	62	119	35.5	55.0	M42 x 2
PN 315	ERTA-38S	38	38	50	60	72	138	41.0	63.0	M52 x 2

DIN 2353 Tube Fittings

• Reducer
ER
 Connects Tube to Tube Port

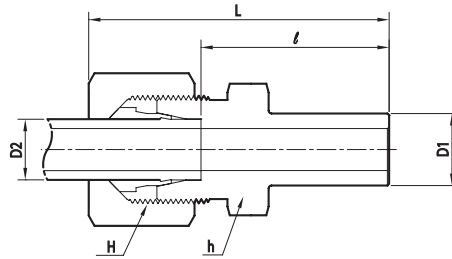

L Series

PN	Part No.	Tube O.D.		H	h	L	ℓ
		D1	D2				
PN315	ER08-06L	8	6	14	12	40	25.5
	ER10L-06L	10	6	14	12	42	27.5
	ER10L-08L		8	17	14	43	27.5
	ER12L-06L	12	6	14	14	42	27.5
	ER12L-08L		8	17	14	43	27.5
	ER12L-10L		10	19	17	44	28.5
	ER15L-06L	15	6	14	19	44	29.0
	ER15L-08L		8	17	19	44	29.0
	ER15L-10L		10	19	19	45	30.0
	ER15L-12L		12	22	19	45	30.0
	ER18L-06L	18	6	14	19	46	31.0
	ER18L-08L		8	17	19	46	31.0
	ER18L-10L		10	19	19	47	32.0
	ER18L-12L		12	22	19	47	32.0
	ER18L-15L		15	27	22	49	33.0
ER22L-06L	22	6	14	24	48	33.0	
ER22L-08L		8	17	24	48	33.0	
ER22L-10L		10	19	24	49	34.0	
ER22L-12L		12	22	24	49	34.0	
ER22L-15L		15	27	24	50	35.0	
ER22L-18L		18	32	27	51	34.5	
ER28L-06L	28	6	14	30	48	33.0	
ER28L-08L		8	17	30	48	33.0	
ER28L-10L		10	19	30	49	34.0	
ER28L-12L		12	22	30	49	34.0	
ER28L-15L		15	27	30	50	35.0	
ER28L-18L		18	32	30	51	36.0	
ER28L-22L		22	36	32	53	36.5	
ER35L-06L	35	6	14	36	53	38.5	
ER35L-08L		8	17	36	53	38.5	
ER35L-10L		10	19	36	55	39.5	
ER35L-12L		12	22	36	55	39.5	
ER35L-15L		15	27	36	56	40.5	
ER35L-18L		18	32	36	56	40.0	
ER35L-22L		22	36	36	58	42.0	
ER35L-28L		28	41	36	59	42.0	
ER42L-06L	42	6	14	46	56	41.0	
ER42L-08L		8	17	46	56	41.0	
ER42L-10L		10	19	46	58	42.0	
ER42L-12L		12	22	46	58	42.0	
ER42L-15L		15	27	46	60	43.0	
ER42L-18L		18	32	46	60	42.5	
ER42L-22L		22	36	46	62	44.5	
ER42L-28L		28	41	46	64	44.5	
ER42L-35L		35	50	46	67	43.5	

S Series

PN	Part No.	Tube O.D.		H	h	L	ℓ
		D1	D2				
PN630	ER08S-06S	8	6	17	14	43	28.0
	ER10S-06S	10	6	17	14	45	30.5
	ER10S-08S		8	19	17	45	30.5
	ER12S-06S	12	6	17	14	47	32.5
	ER12S-08S		8	19	17	47	32.5
	ER12S-10S		10	22	19	48	32.0
	ER14S-06S	14	6	17	17	51	36.5
	ER14S-08S		8	19	17	51	36.5
	ER14S-10S		10	22	19	52	36.0
	ER14S-12S		12	24	22	52	36.0
	ER16S-06S	16	6	17	17	53	38.5
	ER16S-08S		8	19	17	53	38.5
	ER16S-10S		10	22	19	54	38.0
	ER16S-12S		12	24	22	55	38.5
ER16S-14S	14		27	22	57	39.5	
ER20S-06S	20	6	17	22	58	43.0	
ER20S-08S		8	19	22	58	43.0	
ER20S-10S		10	22	22	59	42.5	
ER20S-12S		12	24	22	59	42.5	
ER20S-14S		14	27	22	62	44.0	
ER20S-16S		16	30	24	62	43.5	
ER25S-06S	25	6	17	27	62	47.5	
ER25S-08S		8	19	27	62	47.5	
ER25S-10S		10	22	27	63	47.0	
ER25S-12S		12	24	27	63	47.0	
ER25S-14S		14	27	27	66	48.5	
ER25S-16S		16	30	27	66	48.0	
ER25S-20S		20	36	30	70	48.0	
ER30S-06S	30	6	17	32	67	52.0	
ER30S-08S		8	19	32	67	52.0	
ER30S-10S		10	22	32	68	51.5	
ER30S-12S		12	24	32	68	51.5	
ER30S-14S		14	27	32	71	53.0	
ER30S-16S		16	30	32	71	52.5	
ER30S-20S		20	36	32	74	52.5	
ER30S-25S		25	46	36	77	53.0	
ER38S-06S	PN 315	6	17	41	72	57.0	
ER38S-08S		8	19	41	72	57.0	
ER38S-10S		10	22	41	73	56.5	
ER38S-12S		12	24	41	73	56.5	
ER38S-14S		14	27	41	76	58.0	
ER38S-16S		16	30	41	76	57.5	
ER38S-20S		20	36	41	79	57.5	
ER38S-25S		25	46	41	82	58.0	
ER38S-30S		30	50	46	89	58.5	

Adjustable Standpipe Reducer

EKOR

Connects Tube to Tube Port

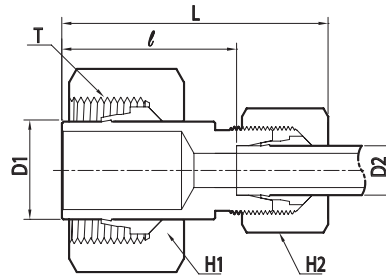

L Series

PN	Part No.	Tube O.D.		H1	H2	L	ℓ	T
		D1	D2					
PN315	EKOR08L-06L	8	6	17	14	38	23.5	M12 x 1.5
	EKOR10L-06L	10	6	19	14	38	23.5	M16 x 1.5
	EKOR10L-08L		8		17	38	23.5	
	EKOR12L-06L	12	6	22	14	38	23.5	M18 x 1.5
	EKOR12L-08L		8		17	38	23.5	
	EKOR12L-10L		10		19	39	24.5	
	EKOR15L-06L	15	6	27	14	38	23.5	M22 x 1.5
	EKOR15L-08L		8		17	38	23.5	
	EKOR15L-10L		10		19	39	24.5	
	EKOR15L-12L		12		22	39	24.5	
	EKOR18L-06L	18	6	32	14	39	24.5	M26 x 1.5
	EKOR18L-08L		8		17	39	24.5	
EKOR18L-10L	10		19		40	25.5		
EKOR18L-12L	12		22		40	25.5		
EKOR18L-15L	15		27		42	26.5		
EKOR22L-06L	22	6	36	14	40	25.5	M30 x 2	
EKOR22L-08L		8		17	40	25.5		
EKOR22L-10L		10		19	41	26.5		
EKOR22L-12L		12		22	41	26.5		
EKOR22L-15L		15		27	43	27.5		
EKOR22L-18L		18		32	43	27.0		
EKOR28L-06L	28	6	41	14	41	26.5	M36 x 2	
EKOR28L-08L		8		17	41	26.5		
EKOR28L-10L		10		19	42	27.5		
EKOR28L-12L		12		22	42	27.5		
EKOR28L-15L		15		27	44	28.5		
EKOR28L-18L		18		32	44	28.0		
EKOR28L-22L		22		36	46	30.0		
EKOR35L-06L	35	6	50	14	46	31.5	M45 x 2	
EKOR35L-08L		8		17	46	31.5		
EKOR35L-10L		10		19	47	32.5		
EKOR35L-12L		12		22	47	32.5		
EKOR35L-15L		15		27	49	33.5		
EKOR35L-18L		18		32	49	33.0		
EKOR35L-22L		22		36	51	35.0		
EKOR35L-28L		28		41	52	35.0		
EKOR42L-10L	42	10	60	19	48	33.5	M52 x 2	
EKOR42L-12L		12		22	48	33.5		
EKOR42L-15L		15		27	50	34.5		
EKOR42L-18L		18		32	50	34.0		
EKOR42L-22L		22		36	52	36.0		
EKOR42L-28L		28		41	53	36.0		
EKOR42L-35L		35		50	57	35.0		

S Series

PN	Part No.	Tube O.D.		H1	H2	L	ℓ	T
		D1	D2					
PN630	EKOR08S-06S	8	6	19	17	40	25.0	M16 x 1.5
	EKOR10S-06S	10	6	22	17	41	26.0	M18 x 1.5
	EKOR10S-08S		8		19	41	26.0	
	EKOR12S-06S	12	6	24	17	42	27.0	M20 x 1.5
	EKOR12S-08S		8		19	42	27.0	
	EKOR12S-10S		10		22	43	26.5	
	EKOR14S-06S	14	6	27	17	44	29.0	M22 x 1.5
	EKOR14S-08S		8		19	44	29.0	
	EKOR14S-10S		10		22	45	28.5	
	EKOR14S-12S		12		24	45	28.5	
EKOR16S-06S	16	6	30	17	44	29.0	M24 x 1.5	
EKOR16S-08S		8		19	44	29.0		
EKOR16S-10S		10		22	45	28.5		
EKOR16S-12S		12		24	45	28.5		
EKOR16S-14S		14		27	80	30.0		
EKOR20S-06S	20	6	36	17	49	34.0	M30 x 2	
EKOR20S-08S		8		19	49	34.0		
EKOR20S-10S		10		22	50	33.5		
EKOR20S-12S		12		24	50	33.5		
EKOR20S-14S		14		27	53	35.0		
EKOR20S-16S		16		30	53	34.5		
EKOR25S-06S	25	6	46	17	52	37.0	M36 x 2	
EKOR25S-08S		8		19	52	37.0		
EKOR25S-10S		10		22	53	36.5		
EKOR25S-12S		12		24	53	36.5		
EKOR25S-14S		14		27	55	37.0		
EKOR25S-16S		16		30	55	36.5		
EKOR25S-20S		20		36	59	37.5		
EKOR30S-06S	30	6	50	17	54	39.0	M42 x 2	
EKOR30S-08S		8		19	54	39.0		
EKOR30S-10S		10		22	55	38.5		
EKOR30S-12S		12		24	55	38.5		
EKOR30S-14S		14		27	58	40.0		
EKOR30S-16S		16		30	58	39.5		
EKOR30S-20S		20		36	61	39.5		
EKOR30S-25S		25		46	64	40.0		
EKOR38S-06S	PN 315	6	60	17	58	43.0	M52 x 2	
EKOR38S-08S		8		19	58	43.0		
EKOR38S-10S		10		22	59	42.5		
EKOR38S-12S		12		24	59	42.5		
EKOR38S-14S		14		27	62	44.0		
EKOR38S-16S		16		30	62	43.5		
EKOR38S-20S		20		36	65	43.5		
EKOR38S-25S		25		46	68	44.0		
EKOR38S-30S		30		50	71	44.5		

Adjustable Standpipe Male Adapter (BSPP/Metric Parallel)

EA-GE/ME

Connects Tube Port to Female Port

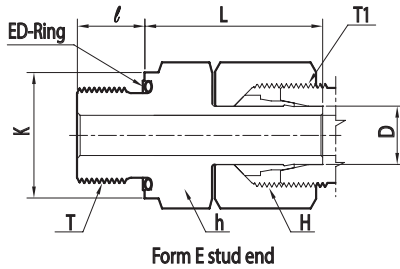

BSPP Parallel - GE

Series	Part No.	Tube O.D D	H	h	K	L	ℓ	T G(PF)	T1
L PN 315	EA06L-01GE	6	14	14	14	24.5	8	1/8	M12 x 1.5
	EA08L-02GE	8	17	19	19	29.5	12	1/4	M14 x 1.5
	EA10L-02GE	10	19	19	19	27.5	12	1/4	M16 x 1.5
	EA12L-03GE	12	22	22	22	34.0	12	3/8	M18 x 1.5
	EA15L-04GE	15	27	27	27	32.0	14	1/2	M22 x 1.5
PN 160	EA18L-04GE	18	32	27	27	31.5	14	1/2	M26 x 1.5
	EA22L-06GE	22	36	32	32	32.5	16	3/4	M30 x 2
	EA28L-08GE	28	41	41	41	35.0	18	1	M36 x 2
	EA35L-10GE	35	50	50	50	42.5	20	1 1/4	M45 x 2
S PN 630	EA42L-12GE	42	60	55	55	46.5	22	1 1/2	M52 x 2
	EA06S-02GE	6	17	19	19	27.0	12	1/4	M14 x 1.5
	EA08S-02GE	8	19	19	19	29.5	12	1/4	M16 x 1.5
	EA10S-03GE	10	22	22	22	32.0	12	3/8	M18 x 1.5
	EA12S-03GE	12	24	22	22	34.0	12	3/8	M20 x 1.5
PN 400	EA12S-04GE	12	24	27	27	34.5	14	1/2	M20 x 1.5
	EA14S-04GE	14	27	27	27	36.5	14	1/2	M22 x 1.5
	EA16S-04GE	16	30	27	27	37.0	14	1/2	M24 x 1.5
	EA16S-06GE	16	30	32	32	39.0	16	3/4	M24 x 1.5
	EA20S-06GE	20	36	32	32	43.0	16	3/4	M30 x 2
PN 315	EA25S-08GE	25	46	41	41	48.0	18	1	M36 x 2
	EA30S-10GE	30	50	50	50	51.0	20	1 1/4	M45 x 2
PN 315	EA38S-12GE	38	60	55	55	60.0	22	1 1/2	M52 x 2

Metric Parallel - ME

Series	Part No.	Tube O.D D	H	h	K	L	ℓ	T M(Metric)	T1
L PN 315	EA06L-10ME	6	14	14	14	24.5	8	M10 x 1	M12 x 1.5
	EA08L-12ME	8	17	17	17	26.5	12	M12 x 1.5	M14 x 1.5
	EA10L-14ME	10	19	19	19	27.5	12	M14 x 1.5	M16 x 1.5
	EA12L-16ME	12	22	22	22	30.5	12	M16 x 1.5	M18 x 1.5
	EA15L-18ME	15	27	24	24	31.5	14	M18 x 1.5	M22 x 1.5
	EA18L-22ME	18	32	27	27	31.5	14	M22 x 1.5	M26 x 1.5
PN 160	EA22L-26ME	22	36	32	32	32.5	16	M26 x 1.5	M30 x 2
	EA28L-33ME	28	41	41	41	35.0	18	M33 x 2	M36 x 2
	EA35L-42ME	35	50	50	50	42.5	20	M42 x 2	M45 x 2
	EA42L-48ME	42	60	55	55	46.5	22	M48 x 2	M52 x 2
S PN 630	EA06S-10ME	6	17	17	17	27.0	12	M12 x 1.5	M14 x 1.5
	EA08S-14ME	8	19	19	19	29.5	12	M14 x 1.5	M16 x 1.5
	EA10S-16ME	10	22	22	22	32.0	12	M16 x 1.5	M18 x 1.5
	EA12S-18ME	12	24	24	24	34.0	12	M18 x 1.5	M20 x 1.5
	EA14S-20ME	14	27	27	27	36.5	14	M20 x 1.5	M22 x 1.5
PN 400	EA16S-22ME	16	30	27	27	37.0	14	M22 x 1.5	M24 x 1.5
	EA20S-27ME	20	36	32	32	43.0	16	M27 x 2	M30 x 2
	EA25S-33ME	25	46	41	41	48.0	18	M33 x 2	M36 x 2
	EA30S-42ME	30	50	50	50	51.0	20	M42 x 2	M42 x 2
	EA38S-48ME	38	60	55	55	60.0	22	M48 x 2	M52 x 2
PN 315	EA30S-10ME	30	50	50	50	51.0	20	1 1/4	M45 x 2
PN 315	EA38S-12ME	38	60	55	55	60.0	22	1 1/2	M52 x 2

● Fittings are supplied with the standard seal material of NBR ED-Ring.

Adjustable Swivel Union

EUE

Connects Tube Ports

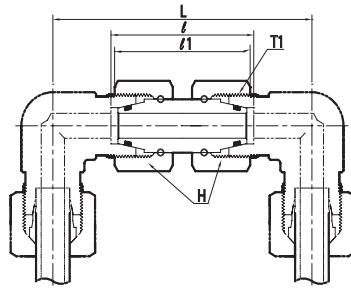

Series	Part No.	Tube O.D.	H	L	ℓ	ℓ1	PN bar	
							C	SS
L	EUE-06L	6	17	64.0	36	34	500	315
	EUE-08L	8	17	64.0	36	34	500	315
	EUE-10L	10	19	67.0	37	36	500	315
	EUE-12L	12	22	71.0	37	36	400	315
	EUE-15L	15	27	82.0	40	39	400	315
	EUE-18L	18	32	89.5	42.5	40.5	400	315
	EUE-22L	22	36	102.0	47	45	250	160
	EUE-28L	28	46	110.0	49	47	250	160
	EUE-35L	35	50	127.0	58	53	250	160
	EUE-42L	42	60	139.0	59	53	250	160
S	EUE-06S	6	17	71.0	39	37	800	630
	EUE-08S	8	19	73.0	39	37	800	630
	EUE-10S	10	22	78.0	43	41	800	630
	EUE-12S	12	24	87.0	44	43	630	630
	EUE-14S	14	27	92.0	48	45	630	630
	EUE-16S	16	30	99.0	50	46	630	400
	EUE-20S	20	36	113.0	60	55	400	400
	EUE-25S	26	46	126.0	66	58	400	400
	EUE-30S	30	50	144.0	73	62	400	400
EUE-38S	38	60	165.0	83	67	400	315	

● Fittings are supplied with the standard seal material of NBR O-Ring.

Adjustable Swivel Elbow

EEW

Connects Tube to Tube Port

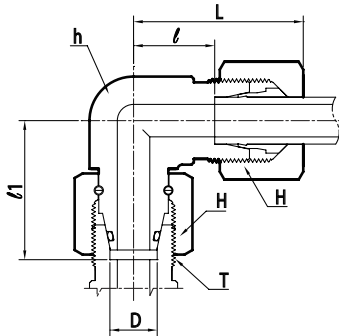

Series	Part No.	Tube O.D.	H	h	L	ℓ	ℓ1	T
L PN 315	EEW-06L	6	14	12	27	12.0	26.0	M12 x 1.5
	EEW-08L	8	17	12	29	14.0	27.5	M14 x 1.5
	EEW-10L	10	19	14	30	15.0	29.0	M16 x 1.5
	EEW-12L	12	22	17	32	17.0	29.5	M18 x 1.5
	EEW-15L	15	27	19	36	21.0	32.5	M22 x 1.5
	EEW-18L	18	32	24	40	23.5	35.5	M26 x 1.5
PN 160	EEW-22L	22	36	27	44	27.5	38.5	M30 x 2
	EEW-28L	28	41	36	47	30.5	41.5	M36 x 2
	EEW-35L	35	50	41	56	34.5	51.0	M45 x 2
S PN 630	EEW-06S	6	17	12	31	16.0	27.0	M14 x 1.5
	EEW-08S	8	19	14	32	17.0	27.5	M16 x 1.5
	EEW-10S	10	22	17	34	17.5	30.0	M18 x 1.5
	EEW-12S	12	24	17	38	21.5	31.0	M20 x 1.5
PN 400	EEW-14S	14	27	19	40	22.0	35.0	M22 x 1.5
	EEW-16S	16	30	24	43	24.5	36.5	M24 x 1.5
	EEW-20S	20	36	27	48	26.5	44.5	M30 x 2
PN 315	EEW-25S	25	36	36	54	30.0	50.0	M36 x 2
	EEW-30S	30	50	41	62	35.5	55.0	M42 x 2
PN 315	EEW-38S	38	60	50	72	41.0	63.0	M52 x 2

● Fittings are supplied with the standard seal material of NBR O-Ring.

Swivel Branch Tee

EET

Connects Tubes to Tube Port

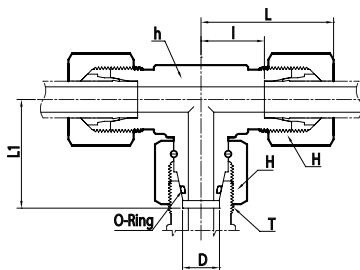

Series	Part No.	Tube O.D. D	H	h	L	L1	ℓ	T
L PN 315	EET-06L	6	14	12	27	26.0	12.0	M12 x 1.5
	EET-08L	8	17	12	29	27.5	14.0	M14 x 1.5
	EET-10L	10	19	14	30	29.0	15.0	M16 x 1.5
	EET-12L	12	22	17	32	29.5	17.0	M18 x 1.5
	EET-15L	15	27	19	36	32.5	21.0	M22 x 1.5
	EET-18L	18	32	24	40	35.5	23.5	M26 x 1.5
PN 160	EET-22L	22	36	27	44	38.5	27.5	M30 x 2
	EET-28L	28	41	36	47	41.5	30.5	M36 x 2
	EET-35L	35	50	41	56	51.0	34.5	M45 x 2
	EET-42L	42	60	50	63	56.0	40.0	M52 x 2
S PN 630	EET-06S	6	17	12	31	27.0	16.0	M14 x 1.5
	EET-08S	8	19	14	32	27.5	17.0	M16 x 1.5
	EET-10S	10	22	17	34	30.0	17.5	M18 x 1.5
	EET-12S	12	24	17	38	31.0	21.5	M20 x 1.5
	EET-14S	14	27	19	40	35.0	22.0	M22 x 1.5
PN 400	EET-16S	16	30	24	43	36.5	24.5	M24 x 1.5
	EET-20S	20	36	27	48	44.5	26.5	M30 x 2
	EET-25S	25	46	36	54	50.0	30.0	M36 x 2
PN 315	EET-30S	30	50	41	62	55.0	35.5	M42 x 2
	EET-38S	38	60	50	72	63.0	41.0	M52 x 2

● Fittings are supplied with the standard seal material of NBR O-Ring.

Adjustable Swivel Run Tee

EEL

Connects Tubes to Tube Port

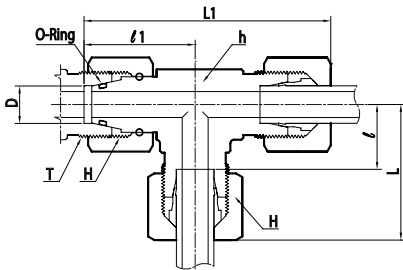

Series	Part No.	Tube O.D. D	H	h	L	L1	ℓ	ℓ1	T
L PN 315	EEL-06L	6	14	12	27	53	12.0	26.0	M12 x 1.5
	EEL-08L	8	17	12	29	56	14.0	27.5	M14 x 1.5
	EEL-10L	10	19	14	30	59	15.0	29.0	M16 x 1.5
	EEL-12L	12	22	17	32	61	17.0	29.5	M18 x 1.5
	EEL-15L	15	27	19	36	69	21.0	32.5	M22 x 1.5
PN 160	EEL-18L	18	32	24	40	75	23.5	35.5	M26 x 1.5
	EEL-22L	22	36	27	44	82	27.5	38.5	M30 x 2
	EEL-28L	28	41	36	47	89	30.5	41.5	M36 x 2
	EEL-35L	35	50	41	56	107	34.5	51.0	M45 x 2
S PN 630	EEL-42L	42	60	50	63	119	40.0	56.0	M52 x 2
	EEL-06S	6	17	12	31	58	16.0	27.0	M14 x 1.5
	EEL-08S	8	19	14	32	59	17.0	27.5	M16 x 1.5
	EEL-10S	10	22	17	34	64	17.5	30.0	M18 x 1.5
	EEL-12S	12	24	17	38	69	21.5	31.0	M20 x 1.5
PN 400	EEL-14S	14	27	19	40	75	22.0	35.0	M22 x 1.5
	EEL-16S	16	30	24	43	79	24.5	36.5	M24 x 1.5
	EEL-20S	20	36	27	48	93	26.5	44.5	M30 x 2
	EEL-25S	25	46	36	54	104	30.0	50.0	M36 x 2
PN 315	EEL-30S	30	50	41	62	117	35.5	55.0	M42 x 2
PN 315	EEL-38S	38	60	50	72	135	41.0	63.0	M52 x 2

● Fittings are supplied with the standard seal material of NBR O-Ring..

DIN 2353 Tube Fittings

Adjustable Swivel Reducer

ERED

Connects Tube to Tube Port

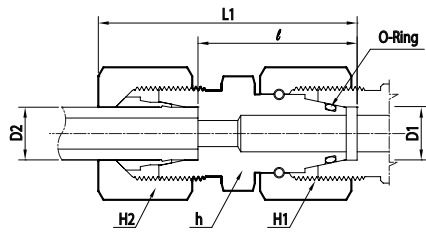

L Series

PN	Part No.	Tube O.D.		H1	H2	h	L	ℓ
		D1	D2					
PN315	ERED08L-06L	8	6	17	14	14	39.0	24.5
	ERED10L-06L	10	6	19	14	17	39.5	24.5
	ERED10L-08L		8		17		39.5	24.5
	ERED12L-06L	12	6	22	14	17	40.0	25.0
	ERED12L-08L		8		17		40.0	25.0
	ERED12L-10L		10		19		41.0	26.0
	ERED15L-06L	15	6	27	14	22	42.0	27.5
	ERED15L-08L		8		17		42.0	27.5
	ERED15L-10L		10		19		43.0	28.5
	ERED15L-12L		12		22		43.0	28.5
	ERED18L-06L	18	6	32	14	25	43.0	28.0
	ERED18L-08L		8		17		43.0	28.0
	ERED18L-10L		10		19		44.5	29.5
	ERED18L-12L		12		22		44.5	29.5
	ERED18L-15L		15		27		45.5	30.5
ERED22L-06L	22	6	36	14	28.5	47.0	32.0	
ERED22L-08L		8		17		47.0	32.0	
ERED22L-10L		10		19		48.0	33.0	
ERED22L-12L		12		22		48.0	33.0	
ERED22L-15L		15		27		49.0	34.0	
ERED22L-18L		18		32		50.0	33.5	
ERED28L-06L	28	6	41	14	36	49.0	34.0	
ERED28L-08L		8		17		49.0	34.0	
ERED28L-10L		10		19		50.0	35.0	
ERED28L-12L		12		22		50.0	35.0	
ERED28L-15L		15		27		51.0	36.0	
ERED28L-18L		18		32		52.0	35.5	
ERED28L-22L		22		36		54.0	37.5	
ERED35L-06L	35	6	50	14	46	55.0	40.0	
ERED35L-08L		8		17		55.0	40.0	
ERED35L-10L		10		19		56.0	41.0	
ERED35L-12L		12		22		56.0	41.0	
ERED35L-15L		15		27		57.0	42.0	
ERED35L-18L		18		32		58.0	41.5	
ERED35L-22L		22		36		60.0	43.5	
ERED35L-28L		28		41		60.0	43.5	
ERED42L-06L	42	6	60	14	50	55.0	40.5	
ERED42L-08L		8		17		55.0	40.5	
ERED42L-10L		10		19		56.0	41.5	
ERED42L-12L		12		22		56.0	41.5	
ERED42L-15L		15		27		58.0	42.5	
ERED42L-18L		18		32		58.0	42.0	
ERED42L-22L		22		36		60.0	44.0	
ERED42L-28L		28		41		61.0	44.0	
ERED42L-35L		35		50		65.0	43.0	

S Series

PN	Part No.	Tube O.D.		H1	H2	h	L	ℓ
		D1	D2					
PN630	ERED08S-06S	8	6	19	17	17	44.0	28.0
	ERED10S-06S	10	6	22	17	17	44.0	29.5
	ERED10S-08S		8		19		44.0	29.5
	ERED12S-06S	12	6	24	17	19	45.0	30.0
	ERED12S-08S		8		19		45.0	30.0
	ERED12S-10S		10		22		46.0	29.5
	ERED14S-06S	14	6	27	17	22	47.5	33.0
	ERED14S-08S		8		19		47.5	33.0
	ERED14S-10S		10		22		48.5	32.5
	ERED14S-12S		12		24		48.5	32.5
	ERED16S-06S	16	6	30	17	24	50.0	35.0
	ERED16S-08S		8		19		50.0	35.0
ERED16S-10S	10		22		51.0		34.5	
ERED16S-12S	12		24		51.0		34.5	
ERED16S-14S	14		27		54.0		36.0	
ERED20S-06S	20	6	36	17	28.5	54.0	39.0	
ERED20S-08S		8		19		54.0	39.0	
ERED20S-10S		10		22		55.0	38.5	
ERED20S-12S		12		24		55.0	38.5	
ERED20S-14S		14		27		58.0	40.0	
ERED20S-16S		16		30		58.0	39.5	
ERED25S-06S	25	6	46	17	36	58.0	43.5	
ERED25S-08S		8		19		58.0	43.5	
ERED25S-10S		10		22		59.0	43.0	
ERED25S-12S		12		24		59.0	43.0	
ERED25S-14S		14		27		62.0	44.5	
ERED25S-16S		16		30		62.0	44.0	
ERED25S-20S		20		36		66.0	44.0	
ERED30S-06S	30	6	50	17	41	66.0	51.0	
ERED30S-08S		8		19		66.0	51.0	
ERED30S-10S		10		22		67.0	50.5	
ERED30S-12S		12		24		67.0	50.5	
ERED30S-14S		14		27		70.0	52.0	
ERED30S-16S		16		30		70.0	51.5	
ERED30S-20S		20		36		73.0	51.5	
ERED30S-25S		25		46		76.0	52.0	
ERED38S-06S	38	6	60	17	50	70.5	56.0	
ERED38S-08S		8		19		70.5	56.0	
ERED38S-10S		10		22		71.5	55.5	
ERED38S-12S		12		24		71.5	55.5	
ERED38S-14S		14		27		74.5	57.0	
ERED38S-16S		16		30		74.5	56.5	
ERED38S-20S		20		36		78.5	56.5	
ERED38S-25S		25		46		81.5	57.0	
ERED38S-30S		30		50		85.5	58.5	

● Fittings are supplied with the standard seal material of NBR O-Ring.

Adjustable Swivel Male Adapter (BSPP/Metric Parallel)

EEGE-GE/ME

Connects Tube Port to Female Port

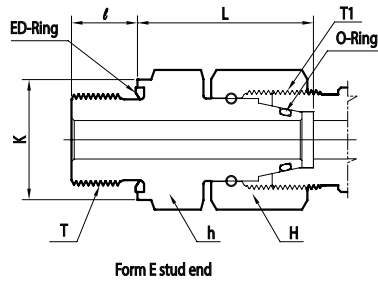

BSPP Parallel - GE

Series	Part No.	Tube O.D. D	H	h	K	L	ℓ	T G(PF)	T1
L PN 315	EEGE06L-01GE	6	14	14	14	24.5	8	1/8	M12 x 1.5
	EEGE08L-02GE	8	17	19	19	29.5	12	1/4	M14 x 1.5
	EEGE10L-02GE	10	19	19	19	27.5	12	1/4	M16 x 1.5
	EEGE12L-03GE	12	22	22	22	34.0	12	3/8	M18 x 1.5
	EEGE15L-04GE	15	27	27	27	32.0	14	1/2	M22 x 1.5
	EEGE18L-04GE	18	32	27	27	31.5	14	1/2	M26 x 1.5
PN 160	EEGE22L-06GE	22	36	32	32	32.5	16	3/4	M30 x 2
	EEGE28L-08GE	28	41	41	41	35.0	18	1	M36 x 2
	EEGE35L-10GE	35	50	50	50	42.5	20	1 1/4	M45 x 2
	EEGE42L-12GE	42	60	55	55	46.5	22	1 1/2	M52 x 2
S PN 630	EEGE06S-02GE	6	17	19	19	27.0	12	1/4	M14 x 1.5
	EEGE08S-02GE	8	19	19	19	29.5	12	1/4	M16 x 1.5
	EEGE10S-03GE	10	22	22	22	32.0	12	3/8	M18 x 1.5
	EEGE12S-03GE	12	24	22	22	34.0	12	3/8	M20 x 1.5
	EEGE14S-04GE	14	27	27	27	36.5	14	1/2	M22 x 1.5
PN 400	EEGE16S-04GE	16	30	27	27	37.0	14	1/2	M24 x 1.5
	EEGE20S-06GE	20	36	32	32	43.0	16	3/4	M30 x 2
	EEGE25S-08GE	25	46	41	41	48.0	18	1	M36 x 2
	EEGE30S-10GE	30	50	50	50	51.0	20	1 1/4	M42 x 2
PN 315	EEGE38S-12GE	38	60	55	55	60.0	22	1 1/2	M52 x 2

Metric Parallel - ME

Series	Part No.	Tube O.D. D	H	h	K	L	ℓ	T M(Metric)	T1
L PN 315	EEGE06L-10ME	6	14	14	14	24.5	8	M10 x 1	M12 x 1.5
	EEGE08L-12ME	8	17	17	17	26.5	12	M12 x 1.5	M14 x 1.5
	EEGE10L-14ME	10	19	19	19	27.5	12	M14 x 1.5	M16 x 1.5
	EEGE12L-16ME	12	22	22	22	30.5	12	M16 x 1.5	M18 x 1.5
	EEGE15L-18ME	15	27	24	24	31.5	12	M18 x 1.5	M22 x 1.5
	EEGE18L-22ME	18	32	27	27	31.5	14	M22 x 1.5	M26 x 1.5
PN 160	EEGE22L-26ME	22	36	32	32	32.5	16	M26 x 1.5	M30 x 2
	EEGE28L-33ME	28	41	41	40	35.0	18	M33 x 2	M36 x 2
	EEGE35L-42ME	35	50	50	50	42.5	20	M42 x 2	M45 x 2
	EEGE42L-48ME	42	60	55	55	46.5	22	M48 x 2	M52 x 2
S PN 630	EEGE06S-12ME	6	17	17	17	27.0	12	M12 x 1.5	M14 x 1.5
	EEGE08S-14ME	8	19	19	19	29.5	12	M14 x 1.5	M16 x 1.5
	EEGE10S-16ME	10	22	22	22	32.0	12	M16 x 1.5	M18 x 1.5
	EEGE12S-18ME	12	24	24	24	34.0	12	M18 x 1.5	M20 x 1.5
	EEGE14S-20ME	14	27	27	26	36.5	14	M20 x 1.5	M22 x 1.5
PN 400	EEGE16S-22ME	16	30	27	27	37.0	14	M22 x 1.5	M24 x 1.5
	EEGE20S-27ME	20	36	32	32	43.0	16	M27 x 2	M30 x 2
	EEGE25S-33ME	25	46	41	40	48.0	18	M33 x 2	M36 x 2
	EEGE30S-42ME	30	50	50	50	51.0	20	M42 x 2	M42 x 2
PN 315	EEGE38S-48ME	38	60	55	55	60.0	22	M48 x 2	M52 x 2

● Fittings are supplied with the standard seal material of NBR O-Ring & ED-Ring.

DIN 2353 Tube Fittings

Blanking Plugs with ED-Ring EVSTI-GE/ME

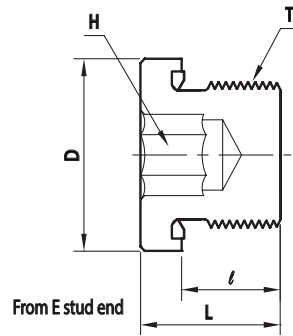

Part No.		T	T	D	H	L	ℓ	PN, bar	
GE	ME	G(PF)	M(Metric)					C	SS
EVSTI-01GE	EVSTI-10ME	1/8	M10 x 1	14.0	5	12.0	8	400	400
-	EVSTI-12ME	-	M12 x 1.5	17.0	6	17.0	12	400	400
EVSTI-02GE	EVSTI-14ME	1/4	M14 x 1.5	19.0	6	17.0	12	400	400
EVSTI-03GE	EVSTI-16ME	3/8	M16 x 1.5	22.0	8	17.0	12	400	400
-	EVSTI-18ME	-	M18 x 1.5	23.9	8	17.0	12	400	400
-	EVSTI-20ME	-	M20 x 1.5	25.9	10	19.0	14	400	400
EVSTI-04GE	EVSTI-22ME	1/2	M22 x 1.5	27.0	10	19.0	14	400	400
-	EVSTI-26ME	-	M26 x 1.5	31.9	12	21.0	16	400	400
EVSTI-06GE	EVSTI-27ME	3/4	M27 x 2	32.0	12	21.0	16	400	400
EVSTI-08GE	EVSTI-33ME	1	M33 x 2	39.9	17	22.5	16	400	400
EVSTI-10GE	EVSTI-42ME	1 1/4	M42 x 2	49.9	22	22.5	16	315	315
EVSTI-12GE	EVSTI-48ME	1 1/2	M48 x 2	55.0	24	22.5	16	315	315

● Plugs are supplied with the standard seal material of NBR ED-Ring.

Blanking Plugs with O-Ring EVSTI-MF

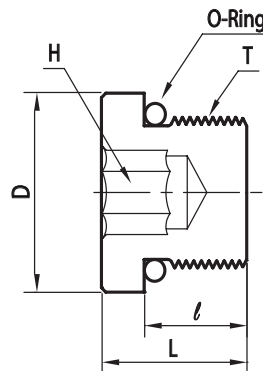

Part No.	T	D	H	L	ℓ	PN, bar
	M(Metric)					C
EVSTI-10MF	M10 x 1	13	5	14.0	10.0	630
EVSTI-12MF	M12 x 1.5	17	6	16.5	11.5	630
EVSTI-14MF	M14 x 1.5	19	6	16.5	11.5	630
EVSTI-16MF	M16 x 1.5	21	6	18.0	13.0	630
EVSTI-18MF	M18 x 1.5	23	8	19.5	14.5	630
EVSTI-22MF	M22 x 1.5	27	10	20.5	15.5	630
EVSTI-26MF	M26 x 1.5	31	12	21.0	16.0	630
EVSTI-27MF	M27 x 2	32	12	24.0	19.0	400
EVSTI-33MF	M33 x 2	38	17	25.5	19.0	400
EVSTI-42MF	M42 x 2	48	22	26.0	19.5	400

● Plugs are supplied with the standard seal material of NBR O-Ring.

• Tube Port Plug with O-Ring

EVKA

Plugs Up Tube Port

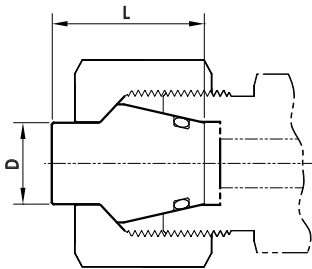

Series	Part No.	Tube O.D.	L	PN, bar		
		D		C	SS	B
L / S	EVKA-06L/S	6	18.5	500	315	200
	EVKA -08L/S	8	18.5	500	315	200
	EVKA-10L/S	10	20.0	500	315	200
	EVKA-12L/S	12	20.5	400	315	200
L	EVKA-15L	15	20.5	400	315	200
	EVKA-18L	18	22.5	400	315	200
	EVKA-22L	22	25.0	250	160	100
	EVKA-28L	28	25.5	250	160	100
	EVKA -35L	35	30.0	250	160	100
	EVKA-42L	42	30.0	250	160	100
S	EVKA-14S	14	22.5	630	630	400
	EVKA-16S	16	23.5	630	400	250
	EVKA-20S	20	28.5	420	400	250
	EVKA-25S	25	29.0	420	400	250
	EVKA-30S	30	30.5	420	400	250
	EVKA-38S	38	33.0	420	315	200

●Plugs are supplied with the standard seal material of NBR O-Ring.

• Tube Cap

ECA

Plugs Up Tube End

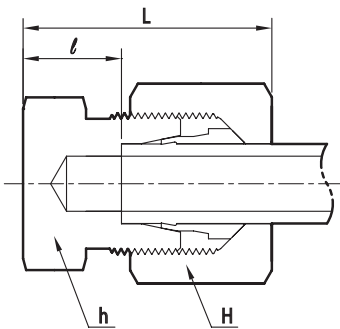

Series	Part No.	Tube O.D.	H	h	L	ℓ
L PN 315	ECA-06L	6	14	12	22	7.0
	ECA-08L	8	17	14	23	8.0
	ECA-10L	10	19	17	24	9.0
	ECA-12L	12	22	19	25	10.0
	ECA-15L	15	27	24	26	11.0
	ECA-18L	18	32	27	28	11.5
PN 160	ECA-22L	22	36	32	30	13.5
	ECA-28L	28	41	41	31	14.5
	ECA-35L	35	50	46	36	14.5
	ECA-42L	42	60	55	39	16.0
S PN 630	ECA-06S	6	17	14	26	11.0
	ECA-08S	8	19	17	28	13.0
	ECA-10S	10	22	19	29	12.5
	ECA-12S	12	24	22	31	14.5
	ECA-14S	14	27	24	34	16.0
PN 400	ECA-16S	16	30	27	34	15.5
	ECA-20S	20	36	32	39	17.5
	ECA-25S	25	46	41	44	20.0
	ECA-30S	30	50	46	47	20.5
PN 315	ECA-38S	38	60	55	54	23.0

• Male Female Adapter (BSPP Parallel)

EMFAD-GB

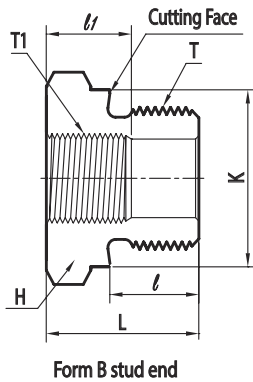

Part No.	H	K	L	ℓ	ℓ1	Male Stud- T	Female Stud- T1	PN bar		
						G(PF)	G(PF)	C	SS	B
EMFAD03-01GB	22	22	22.5	12	8	3/8	1/8	400	400	250
EMFAD04-01GB	27	26	24.0	14	8	1/2	1/8	400	400	250
EMFAD04-02GB	27	26	24.0	14	12	1/2	1/4	315	315	200
EMFAD06-02GB	32	32	26.0	16	12	3/4	1/4	315	315	200
EMFAD06-03GB	32	32	26.0	16	12	3/4	3/8	315	315	200
EMFAD08-02GB	41	39	29.0	18	12	1	1/4	315	315	-
EMFAD08-03GB	41	39	29.0	18	12	1	3/8	315	315	200
EMFAD08-04GB	41	39	29.0	18	14	1	1/2	315	315	200
EMFAD10-04GB	50	49	32.0	20	14	1 1/4	1/2	160	160	100
EMFAD10-06GB	50	49	32.0	20	16	1 1/4	3/4	160	160	100
EMFAD12-04GB	55	55	36.0	22	14	1 1/2	1/2	160	160	100
EMFAD12-06GB	55	55	36.0	22	16	1 1/2	3/4	160	160	100
EMFAD12-08GB	55	55	36.0	22	18	1 1/2	1	160	160	100

• Male Female Adapter (BSPP Parallel)

EMFAE-GB

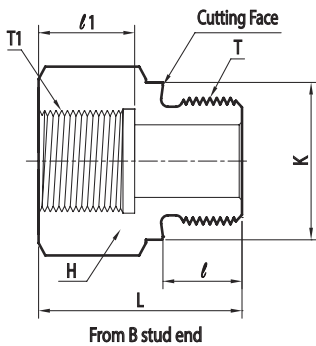

Part No.	d	H	K	L	ℓ	ℓ1	Male Stud- T	Female Stud- T1	PN bar		
							G(PF)	G(PF)	C	SS	B
EMFAE01-02GB	4	19	14	31	8	17.0	1/8	1/4	400	400	250
EMFAE01-03GB	4	24	14	32	8	17.0	1/8	3/8	400	400	250
EMFAE02-01GB	5	19	18	28	12	12.0	1/4	1/8	400	400	250
EMFAE02-03GB	5	24	18	36	12	17.0	1/4	3/8	400	400	250
EMFAE02-04GB	5	30	18	40	12	20.0	1/4	1/2	400	400	250
EMFAE02-06GB	5	36	18	43	12	22.0	1/4	3/4	315	315	200
EMFAE03-02GB	8	22	22	36	12	17.0	3/8	1/4	400	400	250
EMFAE03-04GB	8	30	22	41	12	20.0	3/8	1/2	400	400	250
EMFAE03-06GB	8	36	22	44	12	22.0	3/8	3/4	315	315	200
EMFAE04-03GB	12	27	26	36	14	17.0	1/2	3/8	315	315	200
EMFAE04-06GB	12	36	26	46	14	22.0	1/2	3/4	315	315	200
EMFAE04-08GB	12	41	26	49	14	24.5	1/2	1	315	315	200
EMFAE04-10GB	10	55	26	53	14	26.5	1/2	1 1/4	160	160	-
EMFAE06-04GB	16	32	32	41	16	20.0	3/4	1/2	315	315	200
EMFAE06-08GB	16	41	32	51	16	24.5	3/4	1	315	315	200
EMFAE06-10GB	16	55	32	55	16	26.5	3/4	1 1/4	160	160	-
EMFAE06-12GB	16	60	32	57	16	28.5	3/4	1 1/2	160	160	-
EMFAE08-06GB	20	41	39	47	18	22.0	1	3/4	315	315	200
EMFAE08-10GB	20	55	39	57	18	26.5	1	1 1/4	160	160	100
EMFAE08-12GB	20	60	39	59	18	28.5	1	1 1/2	160	160	100
EMFAE10-08GB	25	50	49	52	20	24.5	1 1/4	1	160	160	100
EMFAE10-12GB	25	60	49	60	20	28.5	1 1/4	1 1/2	160	160	100
EMFAE12-10GB	32	55	55	58	22	26.5	1 1/2	1 1/4	160	160	100
EMFAE16-12GB	40	70	68	62	24	28.5	2	1 1/2	160	-	-

• Male Female Adapter (BSPP Parallel)
with ED-Ring
EMFAD-GE

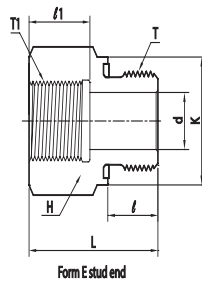

Part No.	H	K	L	ℓ	ℓ1	Mal Stud- T	Female Stud- T1	PN bar	
						G(PF)	G(PF)	C	SS
EMFAD03GE-01G	22	22	22.5	12	8	3/8	1/8	400	400
EMFAD04GE-01G	27	26	24.0	14	8	1/2	1/8	400	400
EMFAD04GE-02G	27	26	24.0	14	12	1/2	1/4	400	400
EMFAD06GE-02G	32	32	26.0	16	12	3/4	1/4	315	315
EMFAD06GE-03G	32	32	26.0	16	12	3/4	3/8	315	315
EMFAD08GE-02G	41	39	29.0	18	12	1	1/4	315	315
EMFAD08GE-03G	41	39	29.0	18	12	1	3/8	315	315
EMFAD08GE -04G	41	39	29.0	18	14	1	1/2	315	315
EMFAD10GE-04G	50	49	32.0	20	14	1 1/4	1/2	315	315
EMFAD10GE-06G	50	49	32.0	20	16	1 1/4	3/4	315	315
EMFAD12GE-04G	55	55	36.0	22	14	1 1/2	1/2	250	250
EMFAD12GE-06G	55	55	36.0	22	16	1 1/2	3/4	250	250
EMFAD12GE-08G	55	55	36.0	22	18	1 1/2	1	250	250

● Adapters are supplied with the standard seal material of NBR ED-Ring.

• Male Female Adapter (BSPP Parallel)
with ED-Ring
EMFAE-GE

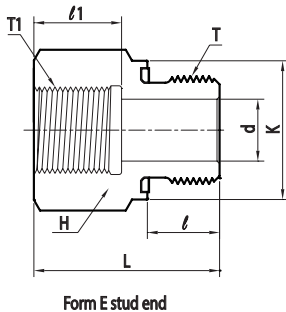

Part No.	d	H	K	L	ℓ	ℓ1	Male Stud- T	Female Stud- T1	PN bar	
							G(PF)	G(PF)	C	SS
EMFAE01GE-02G	4	19	14	31	8	17.0	1/8	1/4	400	400
EMFAE01GE-03G	4	24	14	32	8	17.0	1/8	3/8	400	400
EMFAE02GE-01G	5	19	18	28	12	12.0	1/4	1/8	400	400
EMFAE02GE-03G	5	24	18	36	12	17.0	1/4	3/8	400	400
EMFAE02GE-04G	5	30	18	40	12	20.0	1/4	1/2	400	400
EMFAE02GE-06G	5	36	18	43	12	22.0	1/4	3/4	400	400
EMFAE03GE-02G	8	22	22	36	12	17.0	3/8	1/4	400	400
EMFAE03GE-04G	8	30	22	41	12	20.0	3/8	1/2	400	400
EMFAE03GE-06G	8	36	22	44	12	22.0	3/8	3/4	315	315
EMFAE04GE-03G	12	27	26	36	14	17.0	1/2	3/8	400	400
EMFAE04GE-06G	12	36	26	46	14	22.0	1/2	3/4	315	315
EMFAE04GE-08G	12	41	26	49	14	24.5	1/2	1	315	315
EMFAE04GE-10G	10	55	26	53	14	26.5	1/2	1 1/4	315	315
EMFAE06GE-04G	16	32	32	41	16	20.0	3/4	1/2	315	315
EMFAE06GE-08G	16	41	32	51	16	24.5	3/4	1	315	315
EMFAE06GE-10G	16	55	32	55	16	26.5	3/4	1 1/4	315	315
EMFAE06GE-12G	16	60	32	57	16	28.5	3/4	1 1/2	250	250
EMFAE08GE-06G	20	41	39	47	18	22.0	1	3/4	315	315
EMFAE08GE-10G	20	55	39	57	18	26.5	1	1 1/4	315	315
EMFAE08GE-12G	20	60	39	59	18	28.5	1	1 1/2	250	250
EMFAE10GE-08G	25	50	49	52	20	24.5	1 1/4	1	315	315
EMFAE10GE-12G	25	60	49	60	20	28.5	1 1/4	1 1/2	250	250
EMFAE12GE-10G	32	55	55	58	22	26.5	1 1/2	1 1/4	250	250
EMFAE16GE-12G	40	70	68	62	24	28.5	2	1 1/2	160	-

● Adapters are supplied with the standard seal material of NBR ED-Ring.

DIN 2353 Tube Fittings

Flange Adapters EF

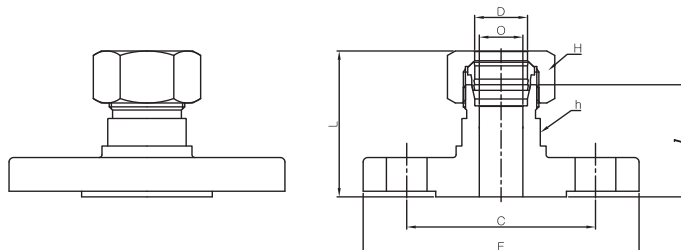

DIN Flanges, Pressure Class PN 16

Part No.	Tube O.D. D	Flange Size, DN	O	Wrench Flat h	H	ℓ	L	C	F
EF-18LF15-10/16-C	18	15	15	27	32	39.9	51.92	65	95
EF-22LF20-10/16-C	22	20	19	32	36	43.9	54	75	105
EF-28LF25-10/16-C	28	25	24	41	41	49.55	62.59	85	115
EF-35LF40-10/16-C	35	40	30	46	50	51.55	67.57	110	150
EF-42LF40-10/16-C	42	40	36	55	60	54.4	69.92	110	150

DIN Flanges, Pressure Class PN 40

Part No.	Tube O.D. D	Flange Size, DN	O	Wrench Flat h	H	ℓ	L	C	F
EF-18LF15-40-C	18	15	15	27	32	41.9	53.92	65	95
EF-42LF32-40-C	42	32	36	55	60	56.4	69.92	100	140
EF-42LF40-40-C	42	32	36	55	60	56.4	71.92	110	150

Banjo Fitting (BSPP/Metric Parallel) with EKA Ring

EBA-G/M

Connects Tube to Female Port

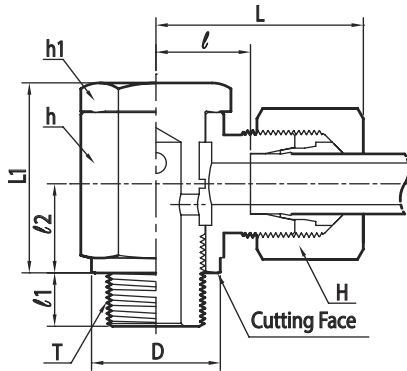

For Tube O.D. up to 15mm

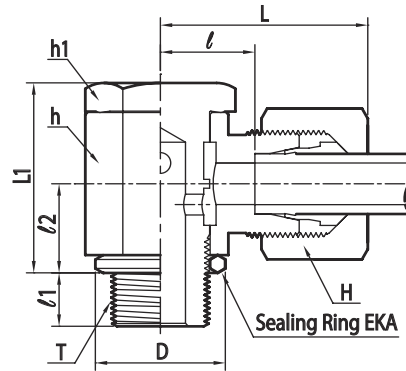

For Tube O.D. 16mm and larger.

BSPP Parallel - G

Series	Part No.	Tube O.D.	D	H	h	h1	L	L1	ℓ	ℓ1	ℓ2	T G(PF)	PN, BAR C
L	EBA06L-01G	6	14.5	14	14	14	25	21.0	10.5	6	10.0	1/8	160
	EBA08L-02G	8	18.5	17	19	19	28	27.0	13.0	9	13.0	1/4	160
	EBA10L-02G	10	18.5	19	19	19	29	27.0	14.0	9	13.0	1/4	160
	EBA12L-03G	12	22.5	22	22	22	30	32.0	15.5	9	15.0	3/8	100
	EBA15L-04G	15	26.5	27	27	27	34	37.5	19.0	11	18.0	1/2	100
	EBA18L-04G	18	26.0	32	30	27	37	44.0	20.5	11	21.5	1/2	100
	EBA22L-06G	22	32.0	36	36	32	42	49.0	25.5	13	24.0	3/4	100
S	EBA06S-02G	6	18.5	17	19	19	30	27.0	15.0	9	13.0	1/4	160
	EBA08S-02G	8	18.5	19	19	19	30	27.0	15.0	9	13.0	1/4	160
	EBA10S-03G	10	22.5	22	22	22	32	32.0	16.0	9	15.0	3/8	100
	EBA12S-03G	12	22.5	24	24	24	33	37.0	17.0	9	18.0	3/8	100
	EBA14S-04G	14	26.5	27	27	27	38	37.0	20.0	11	18.0	1/2	100
	EBA16S-04G	16	26.0	30	30	27	40	44.0	21.5	11	21.5	1/2	100
	EBA20S-06G	20	32.0	36	36	32	46	49.0	24.5	13	24.0	3/4	100

Metric Parallel - M

Series	Part No.	Tube O.D.	D	H	h	h1	L	L1	ℓ	ℓ1	ℓ2	T M(Metric)	PN, BAR C
L	EBA06L-10M	6	14.5	14	14	14	25	21.5	10.5	6	10.0	M10 x 1	160
	EBA08L-12M	8	17.5	17	17	17	27	25.0	12.0	9	12.0	M12 x 1.5	160
	EBA10L-14M	10	19.5	19	19	19	29	27.0	14.0	9	13.0	M14 x 1.5	160
	EBA12L-16M	12	21.5	22	22	22	30	32.0	15.5	9	15.0	M16 x 1.5	100
	EBA15L-18M	15	23.5	27	24	24	33	37.5	17.5	9	18.0	M18 x 1.5	100
	EBA18L-22M	18	27.0	32	30	27	37	44.0	20.5	11	21.5	M22 x 1.5	100
	EBA22L-26M	22	31.0	36	36	32	42	49.0	25.5	13	24.0	M26 x 1.5	100
S	EBA06S-12M	6	17.5	17	17	19	29	25.0	14.0	9	12.0	M12 x 1.5	100
	EBA08S-14M	8	19.5	19	19	19	30	27.0	15.0	9	13.0	M14 x 1.5	100
	EBA10S-16M	10	21.5	22	22	22	32	32.0	16.0	9	15.0	M16 x 1.5	100
	EBA12S-18M	12	23.5	24	24	24	33	37.0	17.0	9	18.0	M18 x 1.5	100
	EBA14S-20M	14	25.5	27	27	27	38	37.0	20.0	11	18.0	M20 x 1.5	100
	EBA16S-22M	16	27.0	30	30	27	40	44.0	21.5	11	21.5	M22 x 1.5	100
	EBA20S-27M	20	32.0	36	36	32	46	49.0	24.5	13	24.0	M27 x 2	100

• Tee High Pressure Banjo Fittings (BSPP/Metric Parallel) with EKA-Ring

EBTH-G/M

Connects Tube to Female Port

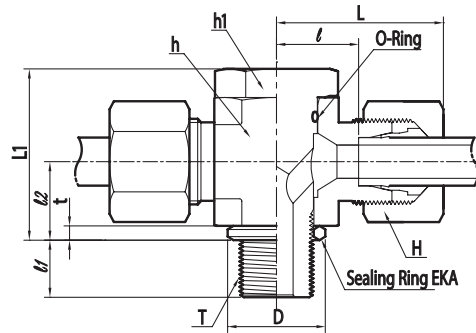

BSPP Parallel - G

Series	Part No.	Tube O.D.	D	H	h	h1	L	L1	l	l1	l2	t	T G(PF)	PN, BAR	
														C	SS
L	EBTH06L-01G	6	14	14	17	17	27	24	12.0	8	10.5	2.5	1/8	250	250
	EBTH08L-02G	8	18	17	22	19	29	30	14.5	12	14.0	3.0	1/4	250	250
	EBTH10L-02G	10	18	19	22	19	30	30	15.5	12	14.0	3.0	1/4	250	250
	EBTH12L-03G	12	22	22	27	24	33	36	18.0	12	16.5	3.0	3/8	250	250
	EBTH15L-04G	15	26	27	32	30	37	45	21.5	14	21.5	4.5	1/2	250	250
	EBTH18L-04G	18	26	32	32	30	37	45	21.0	14	21.5	4.5	1/2	250	250
	EBTH22L-06G	22	32	36	41	36	44	53	27.5	16	24.0	3.5	3/4	160	160
	EBTH28L-08G	28	39	41	50	46	49	66	32.0	18	30.5	3.5	1	160	160
S	EBTH35L-10G	35	49	50	60	55	58	76	36.0	20	35.5	3.5	1 1/4	160	160
	EBTH42L-12G	42	55	60	70	60	63	87	40.5	22	40.5	3.5	1 1/2	160	160
	EBTH06S-03G	6	18	17	22	19	31	30	16.5	12	14.0	3.0	1/4	315	315
	EBTH08S-02G	8	18	19	22	19	31	30	16.5	12	14.0	3.0	1/4	315	315
	EBTH10S-03G	10	22	22	27	24	35	36	18.5	12	16.5	3.0	3/8	315	315
	EBTH12S-03G	12	22	24	27	24	35	36	18.5	12	16.5	3.0	3/8	315	315
	EBTH16S-04G	16	26	30	32	30	40	45	22.0	14	21.5	4.5	1/2	315	315
	EBTH20S-06G	20	32	36	41	36	48	53	26.5	16	24.0	3.5	3/4	160	160
S	EBTH25S-08G	25	39	46	50	46	56	66	31.5	18	30.5	3.5	1	160	160
	EBTH30S-10G	30	49	50	60	55	64	76	37.0	20	35.5	3.5	1 1/4	160	160
	EBTH38S-12G	38	55	60	70	60	72	87	41.5	22	40.5	3.5	1 1/2	160	160

Metric Parallel - M

Series	Part No.	Tube O.D.	D	H	h	h1	L	L1	l	l1	l2	t	T M(Metric)	PN, BAR	
														C	C
L	EBTH06L-10M	6	14	14	17	17	27	24	12.0	8	10.5	2.5	M10 x 1	250	250
	EBTH08L-12M	8	17	17	22	19	29	30	14.5	12	14.0	3.0	M12 x 1.5	250	250
	EBTH10L-14M	10	19	19	22	19	30	30	15.5	12	14.0	3.0	M14 x 1.5	250	250
	EBTH12L-16M	12	21	22	27	24	33	36	18.0	12	16.5	3.0	M16 x 1.5	250	250
	EBTH15L-18M	15	23	27	30	27	36	39.5	20.5	12	18.5	3.0	M18 x 1.5	250	250
	EBTH18L-22M	18	27	32	32	30	37	45	21.0	14	21.5	4.5	M22 x 1.5	250	250
	EBTH22L-26M	22	31	36	41	36	44	53	27.5	16	24.0	3.5	M26 x 1.5	160	160
	EBTH28L-33M	28	39	41	50	46	49	66	32.0	18	30.5	3.5	M33 x 2	160	160
S	EBTH35L-42M	35	49	50	60	55	58	76	36.0	20	35.5	3.5	M42 x 2	160	160
	EBTH42L-48M	42	55	60	70	60	63	87	40.5	22	40.5	3.5	M48 x 2	160	160
	EBTH06S-12M	6	17	17	22	19	31	30	16.5	12	14.0	3.0	M12 x 1.5	315	160
	EBTH08S-14M	8	19	19	22	19	31	30	16.5	12	14.0	3.0	M14 x 1.5	315	315
	EBTH10S-16M	10	21	22	27	24	35	36	18.5	12	16.5	3.0	M16 x 1.5	315	315
	EBTH12S-18M	12	23	24	30	24	35	39.5	20.0	12	18.5	3.0	M18 x 1.5	315	315
	EBTH16S-22M	16	27	30	32	30	36	45	22.0	14	21.5	4.5	M22 x 1.5	315	315
	EBTH20S-27M	20	32	36	41	36	48	53	26.5	16	24.0	3.5	M27 x 2	160	160
S	EBTH25S-33M	25	39	46	50	46	56	66	31.5	18	30.5	3.5	M33 x 2	160	
	EBTH30S-42M	30	49	50	60	55	64	76	37.0	20	35.5	3.5	M42 x 2	160	160
	EBTH38S-48M	38	55	60	70	60	72	87	41.5	22	40.5	3.5	M48 x 2	160	160

• Fittings are supplied with the standard seal material of NBR O-Ring

DIN 2353 Tube Fittings

• Throttle-Free Banjo Fittings (BSPP/Metric Parallel) with EKAZ Ring

EBAT-G/M

Connects Tube to Female Port

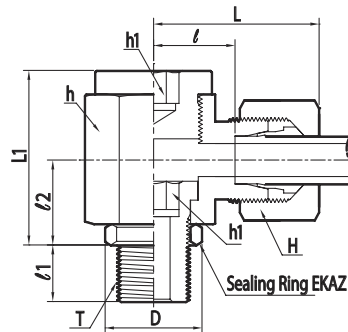

BSPP Parallel - G

Series	Part No.	Tube O.D.	D	H	h	h1	L	L1	ℓ	ℓ1	ℓ2	T G(PF)	PN, BAR C
L	EBAT06L-01G	6	14	14	19	6	27	24	12.5	8	12	PF 1/8	160
	EBAT08L-02G	8	18	17	22	8	29	30	14.5	12	16	PF 1/4	160
	EBAT10L-02G	10	18	19	22	8	30	30	15.5	12	16	PF 1/4	100
	EBAT12L-03G	12	22	22	27	10	33	37	18.0	12	18	PF 3/8	100
	EBAT15L-04G	15	26	27	32	12	37	42	22.0	14	21	PF 1/2	100
	EBAT18L-04G	18	26	32	36	12	38	46	21.5	14	23	PF 1/2	100
	EBAT22L-06G	22	32	36	46	17	45	58	28.5	16	28	PF 3/4	100
	EBAT28L-08G	28	39	41	50	22	48	64	31.5	18	32	PF 1	100
	EBAT35L-10G	35	49	50	60	27	57	76	35.5	20	37	PF 1 1/4	63
EBAT42L-12G	42	55	60	65	32	63	85	40.0	22	42	PF 1 1/2	63	
S	EBAT06S-02G	6	18	17	22	8	31	30	16.5	12	16	PF 1/4	160
	EBAT08S-02G	8	18	19	22	8	31	30	16.5	12	16	PF 1/4	160
	EBAT10S-03G	10	22	22	27	10	35	37	18.5	12	18	PF 3/8	100
	EBAT12S-03G	12	22	24	27	10	35	37	18.5	12	18	PF 3/8	100
	EBAT14S-04G	14	26	27	32	12	41	42	23.0	14	21	PF 1/2	100
	EBAT16S-04G	16	26	30	36	12	41	46	22.5	14	23	PF 1/2	100
	EBAT20S-06G	20	32	36	46	17	49	58	27.5	16	28	PF 3/4	100
	EBAT25S-08G	25	39	46	50	22	55	64	31.0	18	32	PF 1	100
	EBAT30S-10G	30	49	50	60	27	63	76	36.5	20	37	PF 1 1/4	63
EBAT38S-12G	38	55	60	70	32	72	85	41.0	22	42	PF 1 1/2	63	

Metric Parallel - M

Series	Part No.	Tube O.D.	D	H	h	h1	L	L1	ℓ	ℓ1	ℓ2	T M(Metric)	PN, BAR C
L	EBAT06L-10M	6	14	14	19	6	27	24	12.5	8	12	M10 x 1	160
	EBAT08L-12M	8	17	17	22	6	29	30	14.5	12	15	M12 x 1.5	160
	EBAT10L-14M	10	19	19	22	8	30	30	15.5	12	16	M14 x 1.5	100
	EBAT12L-16M	12	21	22	27	10	33	37	18.0	12	18	M16 x 1.5	100
	EBAT15L-18M	15	23	27	30	12	36	40	21.0	12	20	M18 x 1.5	100
	EBAT18L-22M	18	27	32	36	14	38	46	21.5	14	23	M22 x 1.5	100
	EBAT22L-26M	22	31	36	41	17	42	51	26.5	16	25	M26 x 1.5	100
	EBAT28L-33M	28	39	41	50	22	48	64	31.5	18	32	M33 x 2	100
	EBAT35L-42M	35	49	50	60	27	57	76	35.5	20	37	M42 x 2	63
EBAT42L-48M	42	55	60	65	32	63	85	40.0	22	42	M48 x 2	63	
S	EBA 06S-12M	6	17	17	22	6	31	30	16.5	12	15	M12 x 1.5	160
	EBAT08S-14M	8	19	19	22	8	31	30	16.5	12	16	M14 x 1.5	160
	EBAT10S-16M	10	21	22	27	10	35	37	18.5	12	18	M16 x 1.5	100
	EBAT12S-18M	12	23	24	30	12	37	41	20.5	12	20	M18 x 1.5	100
	EBAT14S-20M	14	25	27	32	12	41	42	23.0	14	21	M20 x 1.5	100
	EBAT16S-22M	16	27	30	36	14	41	46	22.5	14	23	M22 x 1.5	100
	EBAT20S-27M	20	32	36	46	17	49	58	27.5	16	28	M27 x 2	100
	EBAT25S-33M	25	39	46	50	22	55	64	31.0	18	32	M33 x 2	100
	EBAT30S-42M	30	49	50	60	27	63	76	36.5	20	37	M42 x 2	63
EBAT38S-48M	38	55	60	70	32	72	85	41.0	22	42	M48 x 2	63	

Throttle-Free Banjo Fittings (BSPP/Metric Parallel)

EBTT-G/M

Connects Tubes to Female Port

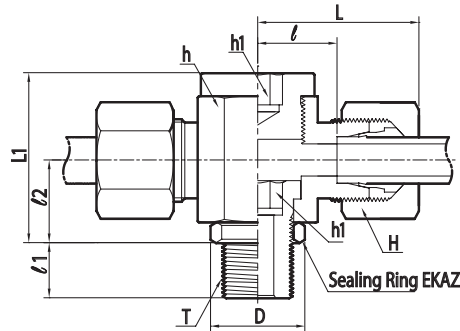

BSPP Parallel - G

Series	Part No.	Tube O.D.	D	H	h	h1	L	L1	ℓ	ℓ1	ℓ2	T G(PF)	PN, BAR C
L	EBTT06L-01G	6	14	14	18	6	27	24	12.0	8	12	1/8	160
	EBTT08L-02G	8	18	17	22	8	29	30	14.0	12	15	1/4	160
	EBTT10L-02G	10	18	19	22	8	30	30	15.0	12	15	1/4	100
	EBTT12L-03G	12	22	22	27	10	32	36	17.5	12	18	3/8	100
	EBTT15L-04G	15	26	27	30	12	35	40	20.0	14	20	1/2	100
	EBTT18L-04G	18	26	32	30	12	36	40	19.5	14	20	1/2	100
	EBTT22L-06G	22	32	36	41	17	43	52	27.0	16	25	3/4	100
	EBTT28L-08G	28	39	41	46	22	46	58	29.5	18	29	1	100
	EBTT35L-10G	35	49	50	55	27	55	69	33.0	20	34	1 1/4	63
EBTT42L-12G	42	55	60	65	32	63	84	40.0	22	41	1 1/2	63	
S	EBTT06S-03G	6	18	17	22	8	31	30	16.0	12	15	1/4	160
	EBTT08S-02G	8	18	19	22	8	31	30	16.0	12	15	1/4	160
	EBTT10S-03G	10	22	22	27	10	34	36	18.0	12	18	3/8	100
	EBTT12S-03G	12	22	24	27	10	34	36	18.0	12	18	3/8	100
	EBTT14S-04G	14	26	27	32	12	40	42	22.0	14	21	1/2	100
	EBTT16S-04G	16	26	30	36	12	40	42	21.5	14	21	1/2	100
	EBTT20S-06G	20	32	36	46	17	50	57	28.5	16	28	3/4	100
	EBTT25S-08G	25	39	46	50	22	55	62	31.0	18	31	1	100
	EBTT30S-10G	30	49	50	60	27	63	74	36.5	20	36	1 1/4	63
EBTT38S-12G	38	55	60	70	32	72	84	41.0	22	41	1 1/2	63	

Metric Parallel - M

Series	Part No.	Tube O.D.	D	H	h	h1	L	L1	ℓ	ℓ1	ℓ2	T M(Metric)	PN, BAR C
L	EBTT06L-10M	6	14	14	18	6	27	24	12.0	8	12	M10 x 1	160
	EBTT08L-12M	8	17	17	20	6	28	27	13.0	12	14	M12 x 1.5	160
	EBTT10L-14M	10	19	19	22	8	30	30	15.0	12	15	M14 x 1.5	100
	EBTT12L-16M	12	21	22	27	10	32	36	17.5	12	18	M16 x 1.5	100
	EBTT15L-18M	15	23	27	30	12	35	39	20.0	12	19	M18 x 1.5	100
	EBTT18L-22M	18	27	32	32	14	37	41	20.5	14	20	M22 x 1.5	100
	EBTT22L-26M	22	31	36	36	17	41	46	24.5	16	22	M26 x 1.5	100
	EBTT28L-33M	28	39	41	46	22	46	58	29.5	18	29	M33 x 2	100
	EBTT35L-42M	35	49	50	55	27	55	69	33.0	20	33	M42 x 2	63
EBTT42L-48M	42	55	60	65	32	63	84	40.0	22	41	M48 x 2	63	
S	EBTT06S-12M	6	17	17	20	6	30	27	15.0	12	14	M12 x 1.5	160
	EBTT08S-14M	8	19	19	22	8	31	30	16.0	12	15	M14 x 1.5	160
	EBTT10S-16M	10	21	22	27	10	34	36	18.0	12	18	M16 x 1.5	100
	EBTT12S-18M	12	23	24	30	12	36	39	19.5	12	19	M18 x 1.5	100
	EBTT14S-20M	14	25	27	32	12	40	41	22.0	14	20	M20 x 1.5	100
	EBTT16S-22M	16	27	30	36	14	42	45	23.5	14	22	M22 x 1.5	100
	EBTT20S-27M	20	32	36	46	17	50	58	28.5	16	28	M27 x 2	100
	EBTT25S-33M	25	39	46	50	22	55	62	31.0	18	31	M33 x 2	100
	EBTT30S-42M	30	49	50	60	27	63	74	36.5	20	36	M42 x 2	63
EBTT38S-48M	38	55	60	70	32	72	84	41.0	22	41	M48 x 2	63	

Sealing Ring

EKA

for EBA/EBAH/EBTH

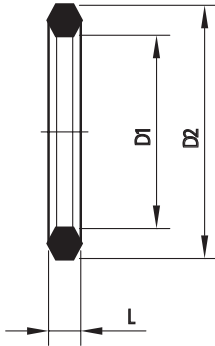

Part No.	External Thread	D1	D2	L1
EKA-01G	PF 1/8	9.8	14	2.5
EKA-02G	PF 1/4	13.3	18	3.0
EKA-03G	PF 3/8	16.8	22	3.0
EKA-04G	PF 1/2	21.1	26	4.5
EKA-06G	PF 3/4	26.6	32	3.5
EKA-08G	PF 1	33.4	39	3.5
EKA-10G	PF 1 1/4	42.1	49	3.5
EKA-12G	PF 1 1/2	48.1	55	3.5
<hr/>				
EKA-10M	M10 x 1.0	10.1	14	3.0
EKA-12M	M12 x 1.5	12.1	17	3.0
EKA-14M	M14 x 1.5	14.1	19	3.0
EKA-16M	M16 x 1.5	16.1	21	3.0
EKA-18M	M18 x 1.5	18.1	23	3.0
EKA-20M	M20 x 1.5	20.1	25	3.0
EKA-22M	M22 x 1.5	22.1	27	4.5
EKA-26M	M26 x 1.5	26.1	31	3.5
EKA-27M	M27 x 2.0	27.1	32	3.5
EKA-33M	M33 x 2.0	33.1	39	3.5
EKA-42M	M42 x 2.0	42.1	49	3.5
EKA-48M	M48 x 2.0	48.1	55	3.5

Sealing Ring

EKAZ

for EBAT/EBTT

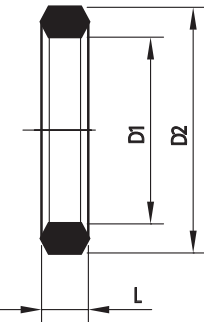

Part No.	External Thread	D1	D2	L1
EKAZ-01G	PF 1/8	9.8	14	3.2
EKAZ-02G	PF 1/4	13.3	18	4.5
EKAZ-03G	PF 3/8	16.8	22	4.5
EKAZ-04G	PF 1/2	21.1	26	5.0
EKAZ-06G	PF 3/4	26.6	32	5.0
EKAZ-08G	PF 1	33.4	39	6.0
EKAZ-10G	PF 1 1/4	42.1	49	6.5
EKAZ-12G	PF 1 1/2	48.1	55	6.5
<hr/>				
EKAZ-10M	M10 x 1.0	10.1	14	3.2
EKAZ-12M	M12 x 1.5	12.1	17	4.2
EKAZ-14M	M14 x 1.5	14.1	19	4.5
EKAZ-16M	M16 x 1.5	16.1	21	4.5
EKAZ-18M	M18 x 1.5	18.1	23	4.5
EKAZ-20M	M20 x 1.5	20.1	25	4.5
EKAZ-22M	M22 x 1.5	22.1	27	4.5
EKAZ-26M	M26 x 1.5	26.1	31	4.5
EKAZ-27M	M27 x 2.0	27.1	32	5.0
EKAZ-33M	M33 x 2.0	33.1	39	6.0
EKAZ-42M	M42 x 2.0	42.1	49	6.5
EKAZ-48M	M48 x 2.0	48.1	55	6.5

• Test Coupling with M16 connection

EEMA3

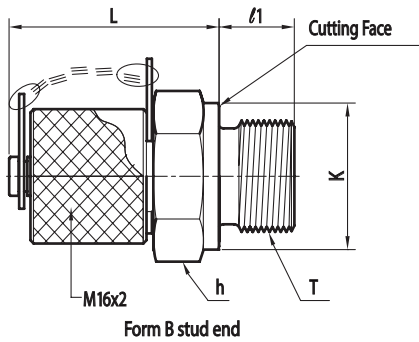

Part No.	K	L	l1	h	T	PN
						bar
EEMA3-01GB	14	36	8	17	PF 1/8	400
EEMA3-02GB	18	36	10	19	PF 1/4	400
EEMA3-03GB	22	36	12	22	PF 3/8	400
EEMA3-04GB	26	36	14	27	PF 1/2	400
EEMA3-10MB	14	36	8	17	M10 x 1	400
EEMA3-12MB	17	36	12	17	M12 x 1.5	400
EEMA3-14MB	19	36	12	19	M14 x 1.5	400
EEMA3-16MB	21	36	12	22	M16 x 1.5	400

• Tee Test Coupling with M16 connection

EEMA3T

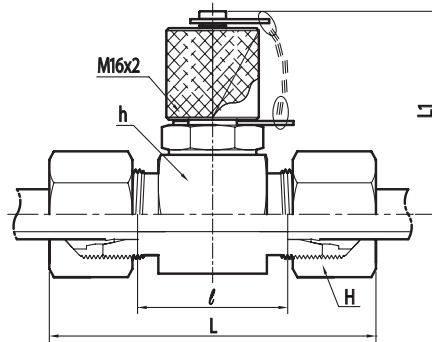

Series	Part No.	Tube O.D.	H	h	L	ℓ	L1	PN, bar	
								C	SS
L	EEMA3T-06L	6	14	24	50	20.5	45	315	315
	EEMA3T-08L	8	17	24	50	20.5	45	315	315
	EEMA3T-10L	10	19	24	52	22.5	45	315	315
	EEMA3T-12L	12	22	24	52	22.5	45	315	315
	EEMA3T-15L	15	27	30	55	24.5	48	315	315
	EEMA3T-18L	18	32	32	56	23.5	49	315	315
	EEMA3T-22L	22	36	36	60	27.5	51	160	160
	EEMA3T-28L	28	41	41	61	27.5	53	160	160
	EEMA3T-35L	35	50	46	69	25.5	56	160	160
S	EEMA3T-42L	42	60	55	70	24.5	60	160	160
	EEMA3T-06S	6	17	24	54	24.5	45	630	630
	EEMA3T-08S	8	19	24	54	24.5	45	630	630
	EEMA3T-10S	10	22	24	56	23.5	45	630	630
	EEMA3T-12S	12	24	24	56	23.5	45	630	630
	EEMA3T-14S	14	27	27	62	26.5	46	630	630
	EEMA3T-16S	16	30	30	62	25.5	48	400	400
	EEMA3T-20S	20	36	36	69	25.5	5	400	400
	EEMA3T-25S	25	46	41	75	26.5	53	400	400
	EEMA3T-30S	30	50	46	81	27.5	56	400	400
EEMA3T-38S	38	60	55	90	29.0	60	315	315	

DIN 2353 Tube Fittings

• Tube Insert

EIL

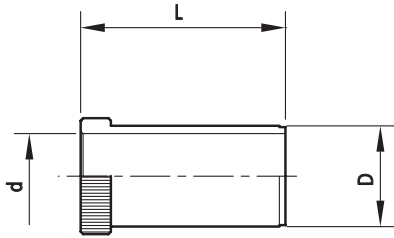

Part No.	Tube O.D.	Tube I.D.	d	D	L
EIL6-1	6	4.0	2.6	3.8	15.5
EIL6-0.75	6	4.5	3.1	4.3	12.5
EIL6-0.5	6	5.0	3.6	4.8	15.5
EIL8-1	8	6.0	4.6	5.8	15.5
EIL10-1.5	10	7.0	5.6	6.8	17.0
EIL10-1	10	8.0	6.6	7.8	16.5
EIL12-1.5	12	9.0	7.6	8.8	16.5
EIL12-1	12	10.0	8.6	9.8	16.5
EIL15-1.5	15	12.0	10.2	11.8	17.0
EIL15-1	15	13.0	11.2	12.8	17.0
EIL16-1	16	14.0	12.2	13.8	17.0
EIL18-1.5	18	15.0	13.2	14.8	17.5
EIL18-1	18	16.0	14.2	15.8	17.5
EIL20-1.5	20	17.0	15.2	16.8	20.0
EIL20-1	20	18.0	16.2	17.8	22.0
EIL22-1.5	22	19.0	17.2	18.8	18.0
EIL22-1	22	20.0	18.2	19.8	18.0
EIL25-2	25	21.0	19.2	20.8	21.5
EIL25-1.5	25	22.0	20.2	21.8	23.5
EIL28-2	28	24.0	22.2	23.8	18.0
EIL28-1.5	28	25.0	23.2	24.8	18.0
EIL30-2	30	26.0	24.2	25.8	23.5
EIL35-2	35	31.0	28.8	30.8	22.5
EIL38-3	38	32.0	29.8	31.8	26.5
EIL38-2.5	38	33.0	30.8	32.8	26.5
EIL42-2	42	38.0	35.8	37.8	23.5

● Apply "Tube Insert" onto the thin wall tube.

• Bulkhead Lock Nut

ELN



Series	Part No.	Tube O.D.		H	L	T
		Light	Heavy			
L	ELN-06L	6	-	17	6	M12 x 1.5
L/S	ELN08L-06S	8	6	19	6	M14 x 1.5
	ELN10L-08S	10	8	22	6	M16 x 1.5
S	ELN12L-10S	12	10	24	6	M18 x 1.5
	ELN-12S	-	12	27	6	M20 x 1.5
L/S	ELN15L-14S	15	14	30	7	M22 x 1.5
S	ELN-16S	-	16	32	7	M24 x 1.5
L	ELN-18L	18	-	36	8	M26 x 1.5
L/S	ELN22L-20S	22	20	41	8	M30 x 2.0
	ELN28L-25S	28	25	46	9	M36 x 2.0
S	ELN-30S	-	30	50	9	M42 x 2.0
L	ELN-35L	35	-	55	9	M45 x 2.0
L/S	ELN42L-38S	42	38	65	10	M52 x 2.0

● Dimensions are as per ISO 8434-1 standard

ED-Ring
9PE

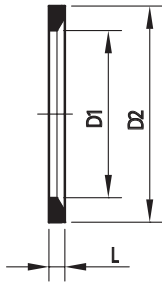

Part No.	For Male Thread		D1	D2	L
	Metric	G(PF)			
9PE-M8-BN	M8 x 1	-	6.5	9.9	1.0
9PE-01G-BN	M10 x 1	PF 1/8	8.4	11.9	1.0
9PE-M12-BN	M12 x 1.5	-	9.8	14.4	1.5
9PE-02G-BN	M14 x 1.5	PF 1/4	11.6	16.5	1.5
9PE-M16-BN	M16 x 1.5	-	13.8	18.9	1.5
9PE-03G-BN	-	PF 3/8	14.7	18.9	1.5
9PE-M18-BN	M18 x 1.5	-	15.7	20.9	1.5
9PE-M20-BN	M20 x 1.5	-	17.8	22.9	1.5
9PE-04G-BN	-	PF 1/2	18.5	23.9	1.5
9PE-M22-BN	M22 x 1.5	-	19.6	24.3	1.5
9PE-06G-BN	M26 x 1.5	PF 3/4	23.9	29.2	1.5
9PE-M27-BN	M27 x 2	PF 3/4	23.9	29.2	1.5
9PE-08G-BN	M33 x 2	PF 1	29.7	35.7	2.0
9PE-10G-BN	M42 x 2	PF 1 1/4	38.8	45.8	2.0
9PE-12G-BN	M48 x 2	PF 1 1/2	44.7	50.7	2.0

O-Ring
9PO

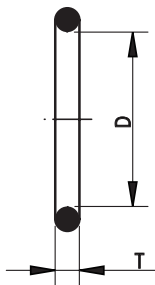

Part No.	D	T
9PO-DS06-BN	4.0	1.5
9PO-DS08-BN	6.0	1.5
9PO-DS10-BN	7.5	1.5
9PO-DS12-BN	9.0	1.5
9PO-DS14-BN	10.0	2.0
9PO-DS16-BN	12.0	2.0
9PO-DS18-BN	15.0	2.0
9PO-DS20-BN	16.3	2.4
9PO-DS22-BN	20.0	2.0
9PO-DS25-BN	20.3	2.4
9PO-DS28-BN	26.0	2.0
9PO-DS30-BN	25.3	2.4
9PO-DS35-BN	32.0	2.5
9PO-DS38-BN	33.3	2.4
9PO-DS42-BN	38.0	2.5

ED-Ring

The standard material of ED-Ring is NBR, to order FKM material, replace “BN” in the part number over the table with the material designator of “VT”. Examples: 9PE-M8-**BN** for NBR, and 9PE-M8-**VT** for FKM.

O-Ring

The standard material of O-Ring is NBR, to order alternative FKM or PTFE material, replace “BN” with the material designator of “VT” for FKM, or “TE” for PTFE. Examples: 9PO-DS06-**BN** for NBR, 9PO-DS06-**VT** for FKM, and 9PO-DS06-**TE** for PTFE.

Refer the allowable working temperature of sealing materialsto the page on 5.

Nut / Cutting Ring / Tube Port Dimension

Tube Port Dimension

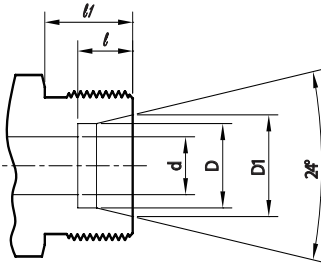

• Cutting Ring
ES

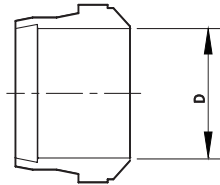

• Nut
EN

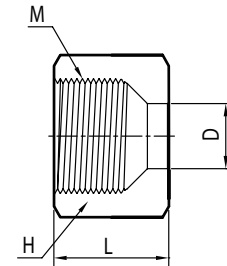

Series	Part No.		Tube O.D.	DN Size	D	D1	d	H	L	M	ℓ	ℓ1
	NUT	Cutting Ring										
LL	EN-04LL	ES-04LL	4	3	4	5.0	3.0	10	11.5	M 8 x 1.0	4.0	8
	EN-06LL	ES-06LL	6	4	6	7.5	4.5	12	12.0	M 10 x 1.0	5.5	8
	EN-08LL	ES-08LL	8	6	8	9.5	6.0	14	12.5	M 12 x 1.0	5.5	9
	EN-10LL	ES-10LL	10	8	10	11.5	8.0	17	12.5	M 14 x 1.0	6.0	9
	EN-12LL	ES-12LL	12	10	12	13.5	10.0	19	13.0	M 16 x 1.0	6.0	9
L	EN-06L	ES-06L	6	4	6	8.1	4.0	14	15.0	M 12 x 1.5	7.0	10
	EN-08L	ES-08L	8	6	8	10.1	6.0	17	15.0	M 14 x 1.5	7.0	10
	EN-10L	ES-10L	10	8	10	12.3	8.0	19	16.0	M 16 x 1.5	7.0	11
	EN-12L	ES-12L	12	10	12	14.3	10.0	22	16.0	M 18 x 1.5	7.0	11
	EN-15L	ES-15L	15	12	15	17.3	12.0	27	17.5	M 22 x 1.5	7.0	12
	EN-18L	ES-18L	18	16	18	20.3	15.0	32	18.0	M 26 x 1.5	7.5	12
	EN-22L	ES-22L	22	20	22	24.3	19.0	36	20.5	M 30 x 2.0	7.5	14
	EN-28L	ES-28L	28	25	28	30.3	24.0	41	21.0	M 36 x 2.0	7.5	14
	EN-35L	ES-35L	35	32	35	38.0	30.0	50	24.0	M 45 x 2.0	10.5	16
	EN-42L	ES-42L	42	40	42	45.0	36.0	60	24.0	M 52 x 2.0	11.0	16
S	EN-06S	ES-06S	6	3	6	8.1	4.0	17	16.5	M 14 x 1.5	7.0	12
	EN-08S	ES-08S	8	4	8	10.1	5.0	19	16.5	M 16 x 1.5	7.0	12
	EN-10S	ES-10S	10	6	10	12.3	7.0	22	17.5	M 18 x 1.5	7.5	12
	EN-12S	ES-12S	12	8	12	14.3	8.0	24	18.0	M 20 x 1.5	7.5	12
	EN-14S	ES-14S	14	10	14	16.3	10.0	27	20.5	M 22 x 1.5	8.0	14
	EN-16S	ES-16S	16	12	16	18.3	12.0	30	21.0	M 24 x 1.5	8.5	14
	EN-20S	ES-20S	20	16	20	22.9	16.0	36	24.0	M 30 x 2.0	10.5	16
	EN-25S	ES-25S	25	20	25	27.9	20.0	46	27.0	M 36 x 2.0	12.0	18
	EN-30S	ES-30S	30	25	30	33.0	25.0	50	29.5	M 42 x 2.0	13.5	20
EN-38S	ES-38S	38	32	38	41.0	32.0	60	32.5	M 52 x 2.0	16.0	22	

Manual Pre-Assembly Tool
EKV

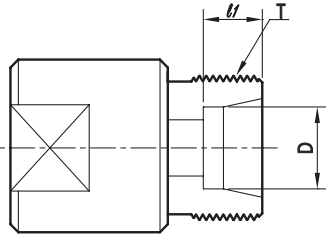

Series	Part No.	Tube O.D.	ℓ1	T
LL	EKV-04LL-C	4	4.0	M8 x 1
	EKV-06LL-C	6	5.5	M10 x 1
	EKV-08LL-C	8	5.5	M12 x 1
L	EKV-06L-C	6	7.0	M12 x 1.5
	EKV-08L-C	8	7.0	M14 x 1.5
	EKV-10L-C	10	7.0	M16 x 1.5
	EKV-12L-C	12	7.0	M18 x 1.5
	EKV-15L-C	15	7.0	M22 x 1.5
	EKV-18L-C	18	7.5	M26 x 1.5
	EKV-22L-C	22	7.5	M30 x 2
	EKV-28L-C	28	7.5	M36 x 2
	EKV-35L-C	35	10.5	M45 x 2
	EKV-42L-C	42	11.0	M52 x 2
	S	EKV-06S-C	6	7.0
EKV-08S-C		8	7.0	M16 x 1.5
EKV-10S-C		10	7.5	M18 x 1.5
EKV-12S-C		12	7.5	M20 x 1.5
EKV-14S-C		14	8.0	M22 x 1.5
EKV-16S-C		16	8.5	M24 x 1.5
EKV-20S-C		20	10.5	M30 x 2
EKV-25S-C		25	12.0	M36 x 2
EKV-30S-C		30	13.5	M42 x 2
EKV-38S-C		38	16.0	M52 x 2

● The Tool is supplied with a protective cap made of brass to protect the external thread of the tool from damage while unused.

Ball Valves

-Quarter Turn Actuation

-Compact Design

-Large Orifice

Application

For systems with compressed air, hydraulic fluids, lubricants, and fuel oil.



Surface Protection

- SS316 ball valves: Passivation
- Steel ball valves: White Zinc Plated

Materials of Construction

Components	Valve Body Material			
	Stainless Steel		Steel	
	Standard / Grade			
	ASTM	DIN	ASTM	DIN
Body	A276 / Type 316	17440 / 1.4571	A108	1651 / 9SMn28K
Stem				
End Connector				
Ball	Stainless Steel 316			
Ball Seats	POM-MoS ₂ , Optional PTFE			
Stem Seal	NBR, Optional FKM			
End Seals				
Handle	Stainless Steel		Steel White Zinc Plated	

Factory Test

- Every valve is factory tested with nitrogen @1000 psig (68.9 bar) for leakage at seat to a maximum allowable leakage rate of 0.1 SCCM.
- Optional 1.5 times hydrostatic shell test is performed to a requirement of no detectable leakage with a liquid leak detector.

DIN 2353 Tube Fittings

Ball Valves VBE Series Steel / Stainless Steel

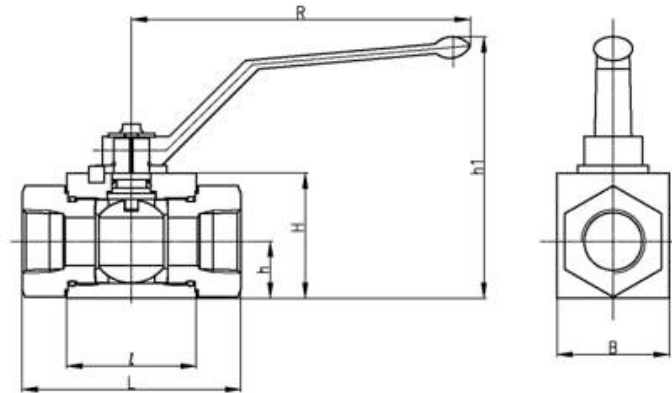

Complete Ordering Number	End Connection Inlet / Outlet	DN	PN	Ball Orifice, mm	End Port Orifice, mm	Dimension, mm						
						L	l	B	h	H	h1	R
VBE1-	06L-SS	6L	4	500	6	5	40	26	13.5	33	82	115
	08L-SS	8L	6			6						
	10L-SS	10L	8			8						
	08S-SS	8S	4			5						
	10S-SS	10S	6			6						
	F2G-SS	Female 1/8" PF	4			4						
	F4G-SS	Female 1/4" PF	6			6						
	F2N-SS	Female 1/8" NPT	4			4						
F4N-SS	Female 1/4" NPT	6	6									
VBE2-	12L-SS	12L	10	500	10	10	43	32	17.5	38	86	115
	12S-SS	12S	8			6						
	14S-SS	14S	10			10						
	F6G-SS	Female 3/8" PF	10			10						
	F6N-SS	Female 3/8" NPT	10			10						
VBE3-	15L-SS	15L	13	500	13	13	48	35	19	40	82	115
	18L-SS	18L				82						
	16S-SS	16S				86						
	20S-SS	20S				90						
	F8G-SS	Female 1/2" PF				83						
	F8N-SS	Female 1/2" NPT				83						
VBE4-	22L-SS	22L	20	400	20	20	62	49	24.5	57	106	160
	25S-SS	25S				101						
	F12G-SS	Female 3/4" PF				109						
	F12N-SS	Female 3/4" NPT				95						
VBE5-	28L-SS	28L	25	315	25	25	66	58	29.5	65	114	160
	35L-SS	35L				108						
	42L-SS	42L				112						
	30S-SS	30S				112						
	38S-SS	38S				120						
	F16G-SS	Female 1" PF				124						
	F16N-SS	Female 1" NPT				113						
	F20G-SS	Female 1 1/4" PF				113						
	F20N-SS	Female 1 1/4" NPT				120						

Ball Valves
VBE Series
 Steel / Stainless Steel

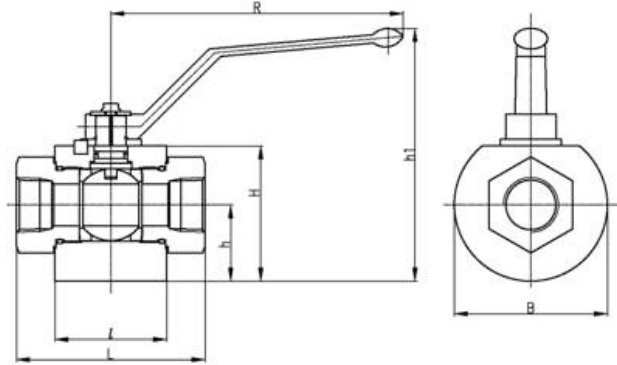

Complete Ordering Number		End Connection	DN	PN	Ball Orifice, mm	End Port Orifice, mm	Dimension, mm						
		Inlet / Outlet					L	I	B	h	H	h1	R
VBE6-	35L-SS	35L	32	210	32	32	156	80	109	54.5	100	132	250
	38S-SS	38S					173						
	F20G-SS	Female 1 1/4" PF					122						
	F20N-SS	Female 1 1/4" NPT					122						
VBE7-	42L-SS	42L	40	210	38	38	171	85	124	62	115	132	250
	F24G-SS	Female 1 1/2" PF					130						
	F24N-SS	Female 1 1/2" NPT					130						
VBE8-	F32G-SS	Female 2" PF	50	210	48	48	140	101	132	66	124	132	250
	F32N-SS	Female 2" NPT					140						

Temperature Ratings

Body	Stainless Steel 316		Carbon Steel	
	Seat	POM	POM	POM
Seal	NBR	FKM	NBR	FKM
Temp.	-30 - 100 °C		-20 - 100 °C	

Pressure Rating

Refer to Nominal Pressure "PN" in the table.

Example: 210 bar (PN 210)

Ordering Information

Ball valves are supplied with standard POM seats and NBR seals.

To order stainless valve, select an ordering number in the table.

Example: VBE6-35L-SS

To order carbon steel valve, replace "SS" in the ordering number with "C".

Example: VBE6-35L-C

To order valve with optional FKM O-ring, insert "VT" in the ordering number

Example: VBE6-35L-VT-C

Non-Return Valves

Application

Hydraulic oil, low flammability hydraulic fluids and compressed air.

Technical Features

- Valves are designed to prevent fluid from reverse flow.
- Valve seals are available in FKM and NBR.

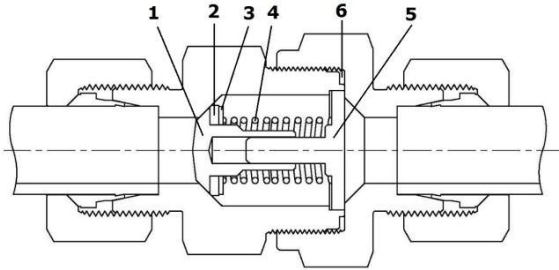

Material of Construction

Components	Body Material	
	Stainless Steel	Steel
1. Poppet	SS316	Steel
2. Disc Seal	FKM	NBR
3. Seal Cover	SS316	Steel
4. Spring	SS304+WPB	Steel (SWP-A)
5. Poppet Guide	SS316	Steel
6. Body Seal	Metal sealing for OD up to 15mm, PTFE sealing for OD 16mm and larger	

Allowable Working Temperature

- Stainless steel Valves: -20 to 200°C with FKM disc seal. -20 to 90°C with optional NBR disc seal.
- Steel Valves: -10 to 90°C with NBR disc seal. -10 to 120°C with optional FKM disc seal.

Valve Installation

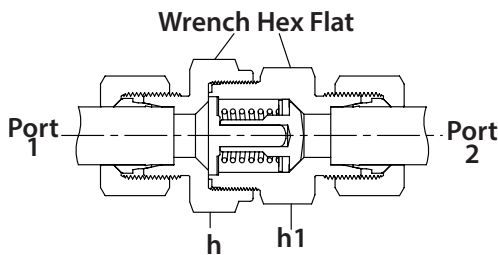

Valve consists of inlet and outlet body where a wrench flat is arranged respectively. The two piece body design requires special care in installation.

While holding up “h” hex on inlet body with a backup wrench, Install the port 1. Do not hold up “h1” hex on outlet body. This may have the valve body disassembled.

Likewise, for port 2 installation, hold up “h1” hex flat on outlet body, not “h” hex on inlet body.

Ordering Information

To order steel valve, select an applicable valve ordering number from the table. VCE1-06L-C
To order stainless steel valve, replace “C” in the ordering number with “SS”. VCE1-06L-SS

Valves are supplied with standard 0.5 bar spring.

To order valve with an optional spring, insert applicable spring designator in the valve ordering number. VCE1-06L-1-SS

Stainless valves are supplied with FKM disc seal, to order the valve with NBR seal, insert the designator “BN” in the part number. VCE1-06L-1-BN-SS

Steel valves are supplied with NBR disc seal, to order the valve with FKM seal, insert the designator “VT” in the part number. VCE1-06L-1-VT-C

Valve Opening Pressure

0.5 bar is standard. Opening pressure of 0.2, 1, 2, 3, and 5 bar is available for option.

Spring Designator	02	05	1	2	3	5
Nominal Opening Pressure	0.2 bar	0.5 bar	1 bar	2 bar	3 bar	5 bar

- The allowance of valve opening pressure is +/- 20%

• Non Return Valves

VCE-L/S

Tube to Tube

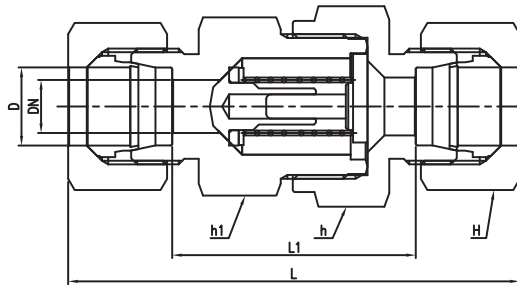

Complete Ordering Number		End Connection	DN	PN	D.	H	h1	h	L	L1
		Inlet/Outlet								
VCE1-	06L-C	6L	3.5	250	6	14	17	17	58	29
	06S-C	6S		400	6	17	19	19	63.5	34.5
	08S-C	8S			8	19			63.5	34.5
VCE2-	08L-C	8L	5.5	250	8	17	19	19	59	30
	10S-C	10S		400	10	22	22	24	72.5	40.5
VCE3-	10L-C	10L	7.5	250	10	19	22	24	69.5	40.5
	12S-C	12S		400	12	24	24	27	74.5	42.5
VCE4-	12L-C	12L	9.5	250	12	22	27	30	72.5	43.5
	14S-C	14S		400	14	27	27	32	82.5	47.5
VCE5-	15L-C	15L	11	250	15	27	27	32	77.5	47.5
	16S-C	16S		400	16	30	32	36	86.5	50.5
VCE6-	18L-C	18L	14	250	18	32	36	36	83.5	51.5
	20S-C	20S	15	400	20	36	41	46	97.5	54.5
VCE7-	22L-C	22L	18	160	22	36	41	46	93.5	61.5
	25S-C	25S	19	250	25	46	46	50	106.5	58.5
VCE8-	28L-C	28L	23	100	28	41	50	55	102.5	69.5
	30S-C	30S	24	250	30	50	60	60	122.5	69.5
VCE9-	35L-C	35L	29	100	35	50	60	60	117.5	74.5
	42L-C	42L		42	60	65	70	119	74	
	38S-C	38S		250	38			60	136.5	75.5

• Non Return Valves

VCE-F

Female to Female

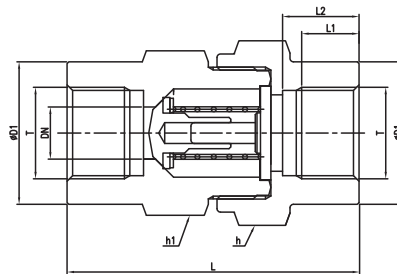

Complete Ordering Number		End Connection	DN	PN	D1	L	L1	L2	h1	h	T (PF)
		Inlet/Outlet									
VCE1-	F2G-C	Female 1/8" PF	3.5	400	19	42.5	8	12	19	19	1/8
	F4G-C	Female 1/4" PF			19	51	12	16	19	19	1/4
VCE3-	F6G-C	Female 3/8" PF	7.5	400	24	60	12	17	24	27	3/8
VCE5-	F8G-C	Female 1/2" PF	11	315	32	72	14	20	32	36	1/2
VCE6-	F12G-C	Female 3/4" PF	15	250	41	84	16	22	41	46	3/4
VCE7-	F16G-C	Female 1" PF	19	250	46	95	18	25.5	46	50	1
VCE8-	F20G-C	Female 1 1/4" PF	24		60	110	20	28	60	60	1 1/4
VCE9-	F24G-C	Female 1 1/2" PF	29		65	114	22	28.5	65	70	1 1/2

• Valves are supplied with the standard 0.5 bar cracking pressure spring.

Fitting Assembly Instruction

Selection of Tube

- Refer to Tube Guide on page 65, 66.

Preparation of Tubes

1. Use like tube and fitting material. The only exception is copper tubing on brass fitting.
2. Using sawing machine, saw off the tube at right angle. Tube cutter is not recommended.
3. Using de-burring tool, lightly de-burr the tube-end inside and outside diameter.

Preparation of Fittings

1. Prior to assembly, lubricate the threads of nut & body, the cutting ring, and 24° cone on the body,
2. Do not use grease for lubrication.

Bending of Tubes

1. Do not bend the tube in the fitting. Use the tube bender prior to assembly.
2. Keep the minimum length of straight tube in the fitting.
3. The straight length 2 times the nut's height is a minimum.

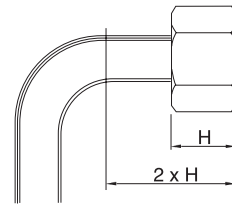

Fitting Assembly with a pre-assembly tool

Fitting pre-assembly in the oiled pre-assembly tool first ensures the positive final assembly on fitting body.

	<p>Step 1</p> <p>Place the pre-oiled nut and cutting ring over the tube in the right direction.</p>
	<p>Step 2</p> <p>Insert the tube (with the cutting ring and nut) into the pre-assembly tool up to tube abutment and hand-tighten the nut</p>
	<p>Step 3</p> <p>Wrench- tighten 1 1/2 turns beyond the hand-tighten position.</p>

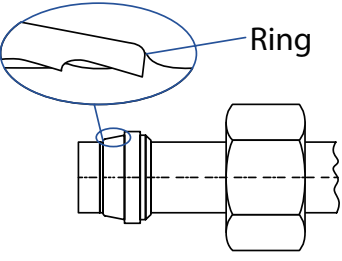
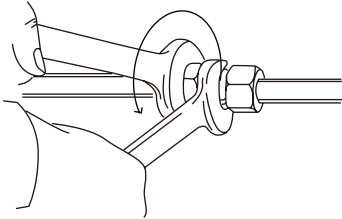
	<p>Step 4</p> <p>Take out the pre-assembly from the pre-assembly tool and untighten the nut to check the ring formed up over the tube.</p> <p>The visible ring in front of the cutting ring is formed up with the penetration of the cutting ring into the tube surface.</p> <p>The ring stops the cutting ring from moving axially but it may turn on tube.</p>
	<p>Step 5</p> <p>Final assembly on fitting body</p> <p>Wrench-tighten the nut by holding up the fitting body with a second wrench until a noticeable increase in torque is felt. Beyond this point tighten the nut 1/4 turn for final assembly.</p> <p>Caution: Turn the nut, never turn the fitting body.</p>

Direct Assembly

1. Place the pre-oiled nut and cutting ring over the tube in the right direction.
2. Insert the tube (with nut and cutting ring) into the fitting body up to tube abutment.
3. Hand-tighten the nut and then wrench-tighten 1 1/2 turns by holding the fitting body with a second wrench for final assembly. **Caution:** Turn the nut, never turn the fitting body.
4. Check the penetration of cutting ring.
A mechanical ring should be formed up in front of cutting ring.
The ring stops the cutting ring from moving axially but it may turn on tube.

Re-assembly

Each time the fitting is dis-assembled, the nut must be re-tightened using the same torque as required for final assembly.

Standpipe Fitting Assembly

Standpipe fittings are generally supplied with pre-assembled cutting ring.
Wrench-tighten the nut 1/4 turn beyond the point a noticeable increase in torque is felt.

EAK and Swivel Fitting Assembly

1. Oil the O-Ring on the fitting.
2. Wrench-tighten the nut 1/4 turn beyond the point a noticeable increase in torque is felt.



Note:

The information shown in this catalog is not for design purpose, but for reference only.
The accuracy of information here is not the liability of our company.

Component Selection

The selection of component for any application or system design must be considered to ensure safe performance. Component function, material compatibility, component pressure and temperature rating, proper installation, operation and maintenance remain the sole responsibility of the system designer and the user. HSME Corporation accepts no liability for any improper selection, installation, operation or maintenance.

HSME Corporation
(주) 협신금속

Corporate Office & Factory
595-1 Hwajeon-dong,
Gangseo-gu, Busan
South Korea 618-280
www.hsmecorp.com

Contact Information

For Overseas Customers / Suppliers

T +82 70 4346 6211 / 6326
F +82 70 8282 5112
E hsme@hsmecorp.com

For Local Customers

T 051-264-7700 - 4
F 051-264-7705
E sales@hsmecorp.com